



GRAND
DESIGN • BUILD

11 BROOKMOUNT - RD

NELLY@GrandDesignBuild.com

DESIGN ETHOS

PLACE . SPACE . VOID

Place is the product of lived space and lived time, a reflection of our states of mind and heart. A home is the outward expression of our souls. It represents the way we want to live, the values and ideals that define us and the intricate ways through which our sense of aesthetic is bound to the world around us.

NELLY MOLAEI

SECOND FLOOR KITCHEN DESIGN

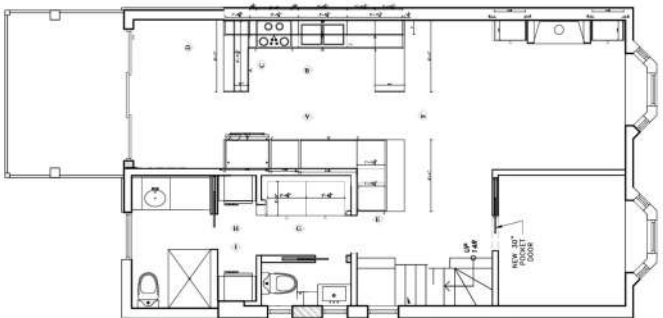

PROJECT TITLE:
11 BROOKMOUNT RD
TITLE:
SECOND FLOOR

All dimensions are subject to verification and adjustment on jobsite to fit job condition.

PRODUCED BY:
N.M
SIGN&DATE:



Majesty CAOK150MAJ



9090 Dawn

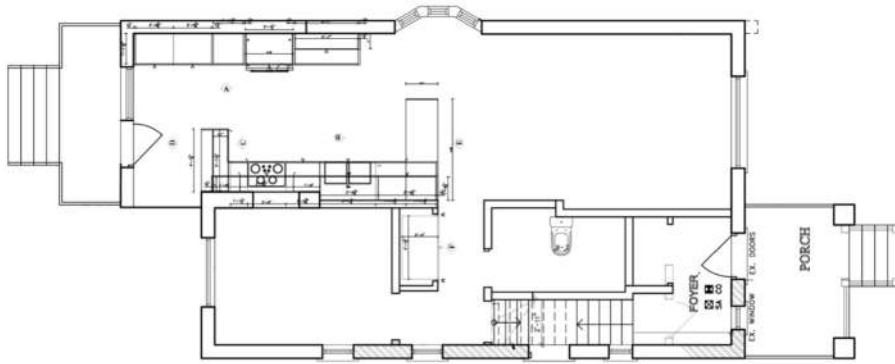

PROJECT TITLE:
11 BROOKMOUNT RD
TITLE:
MAIN FLOOR

All dimensions are subject to verification and adjustment on jobsite to fit job condition.

PRODUCED BY:
N.M
SIGN&DATE:



7021 Luccia



Majesty CAOK150MAJ



WHITE SOFT TOUCH



STONE GREY 728

MAIN FLOOR KITCHEN DESIGN

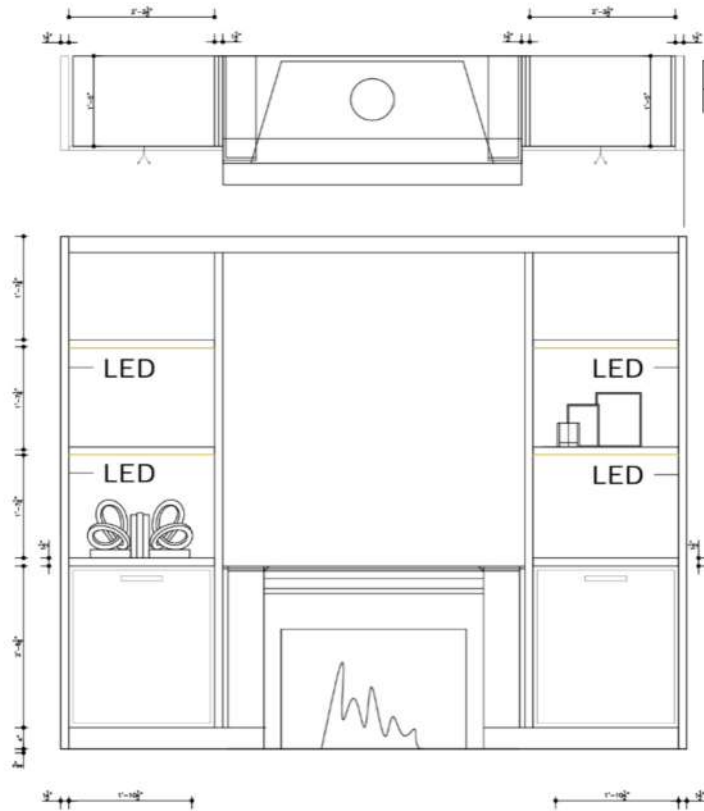

FIRE PLACE & TV WALL DESIGN





SECOND FLOOR BATHROOM



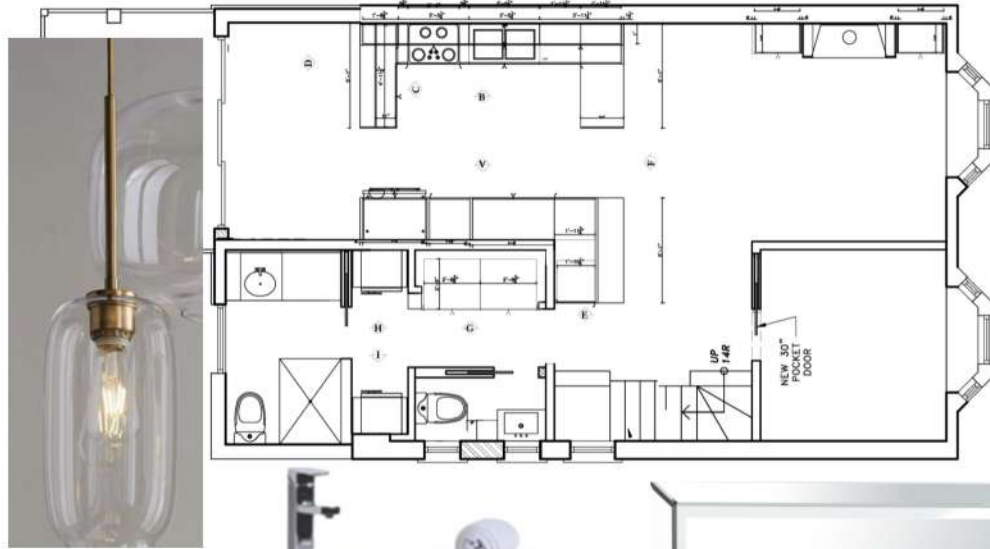

POWDER ROOM
DESIGN

MAIN FLOOR

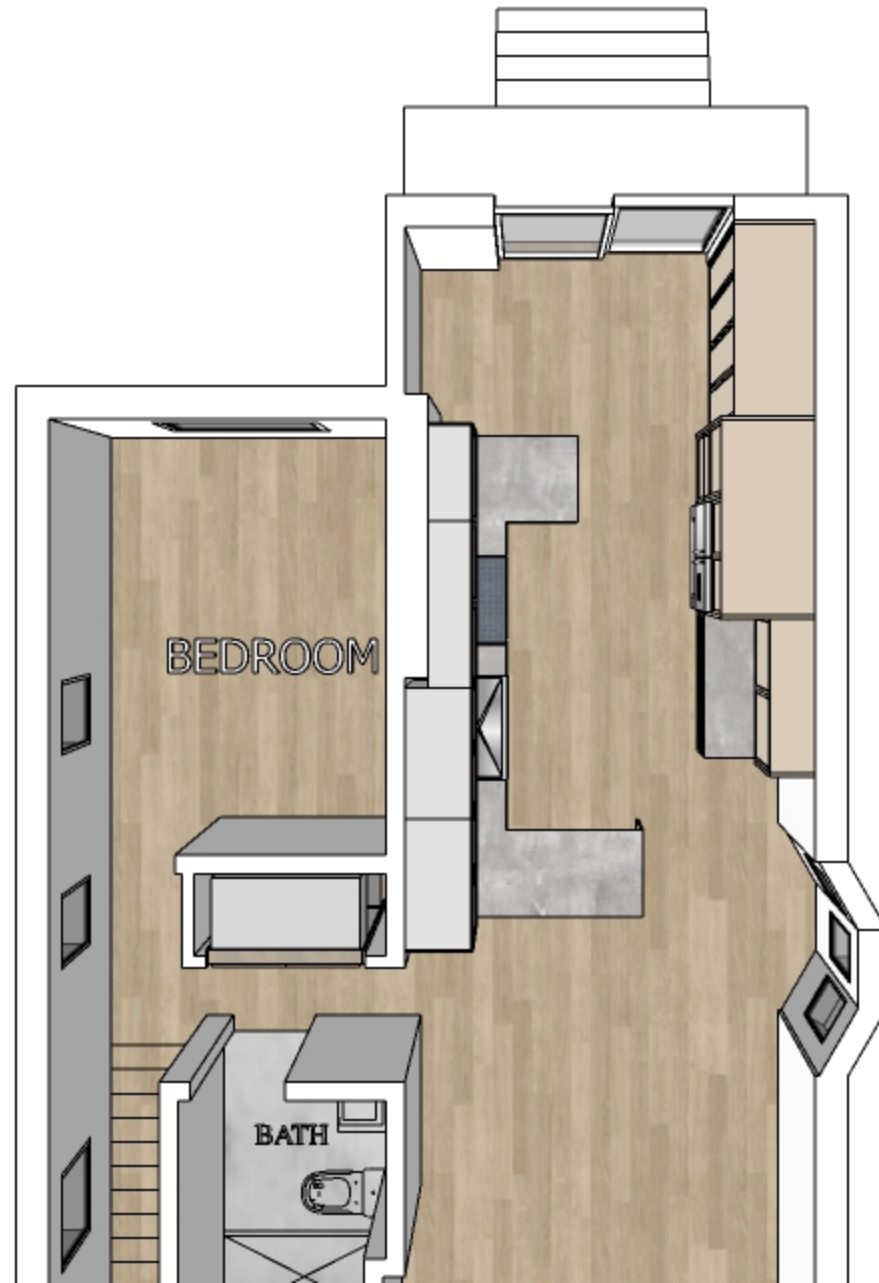















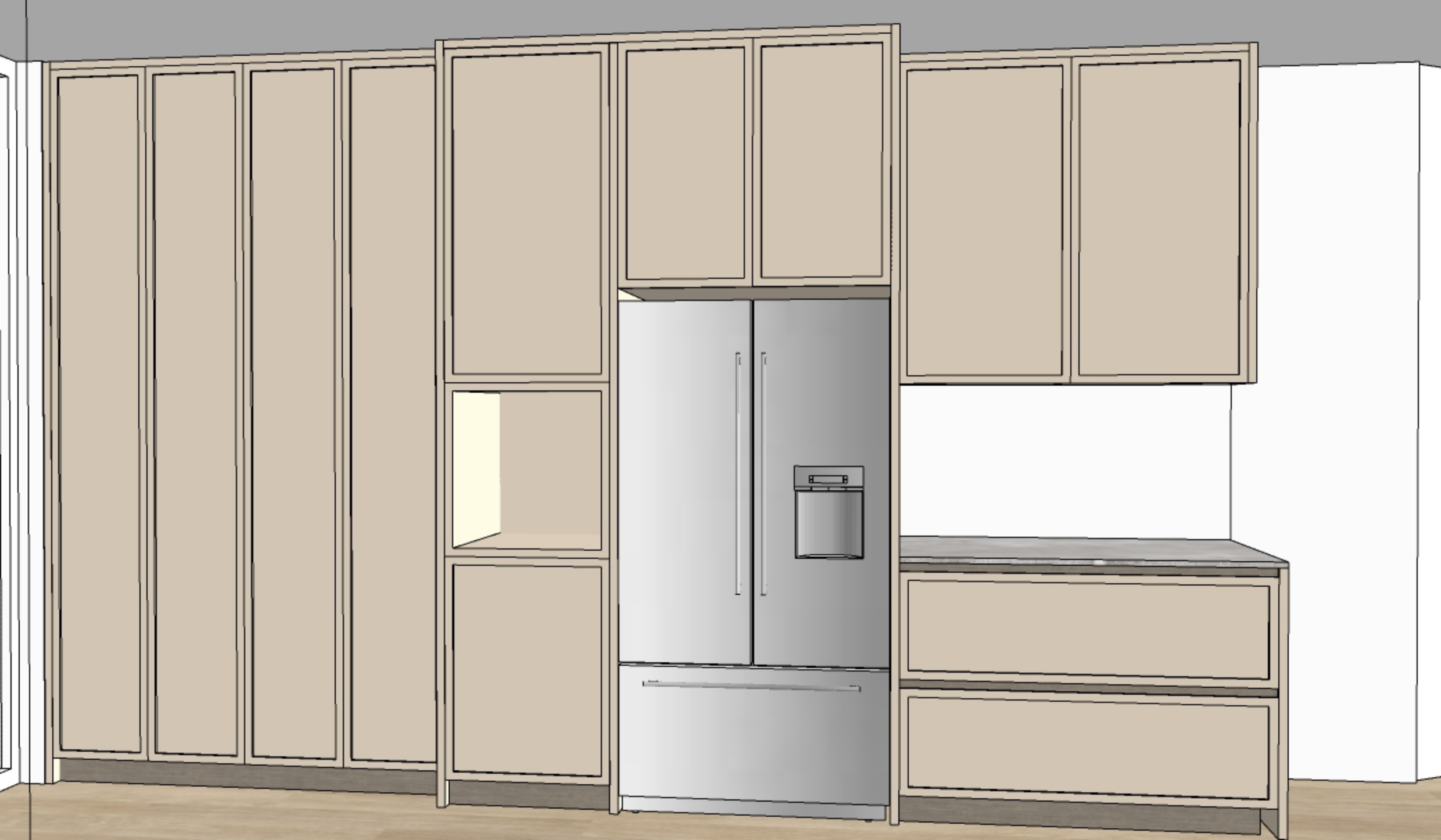



SECOND FLOOR





























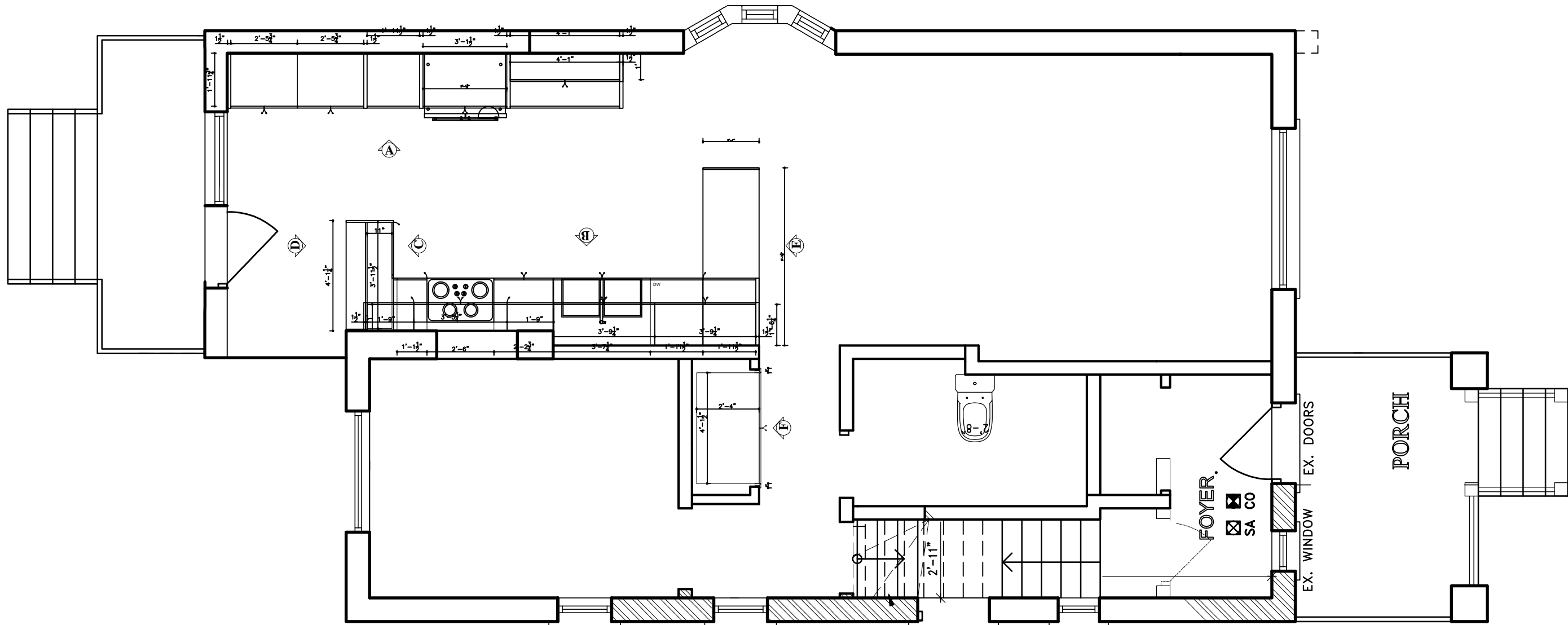

PROJECT TITLE:
11 BROOKMOUNT RD

TITLE:
MAIN FLOOR

All dimensions are subject to verification and adjustment on jobsite to fit job condition.

PRODUCED BY:
N.M

SIGN&DATE:

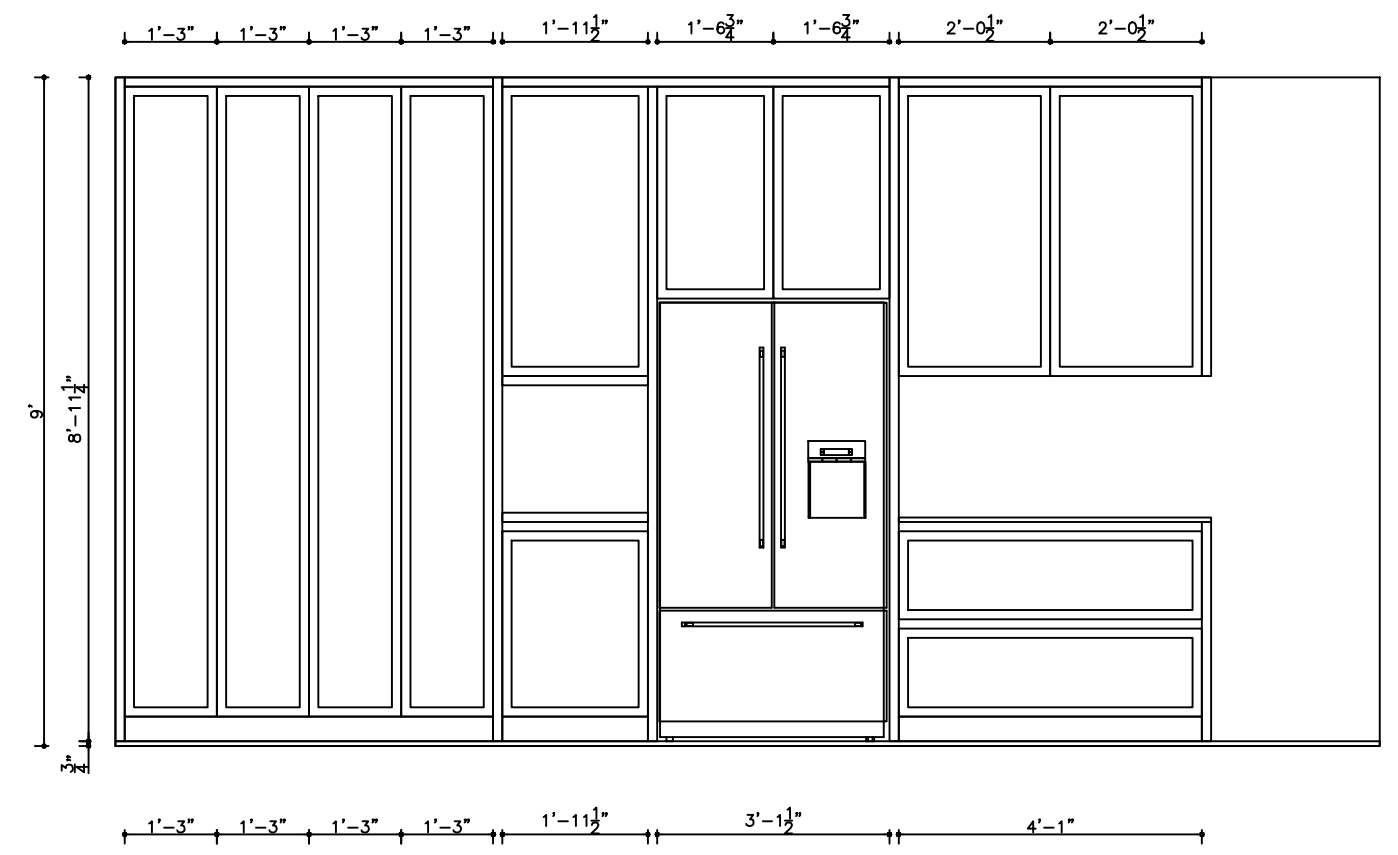
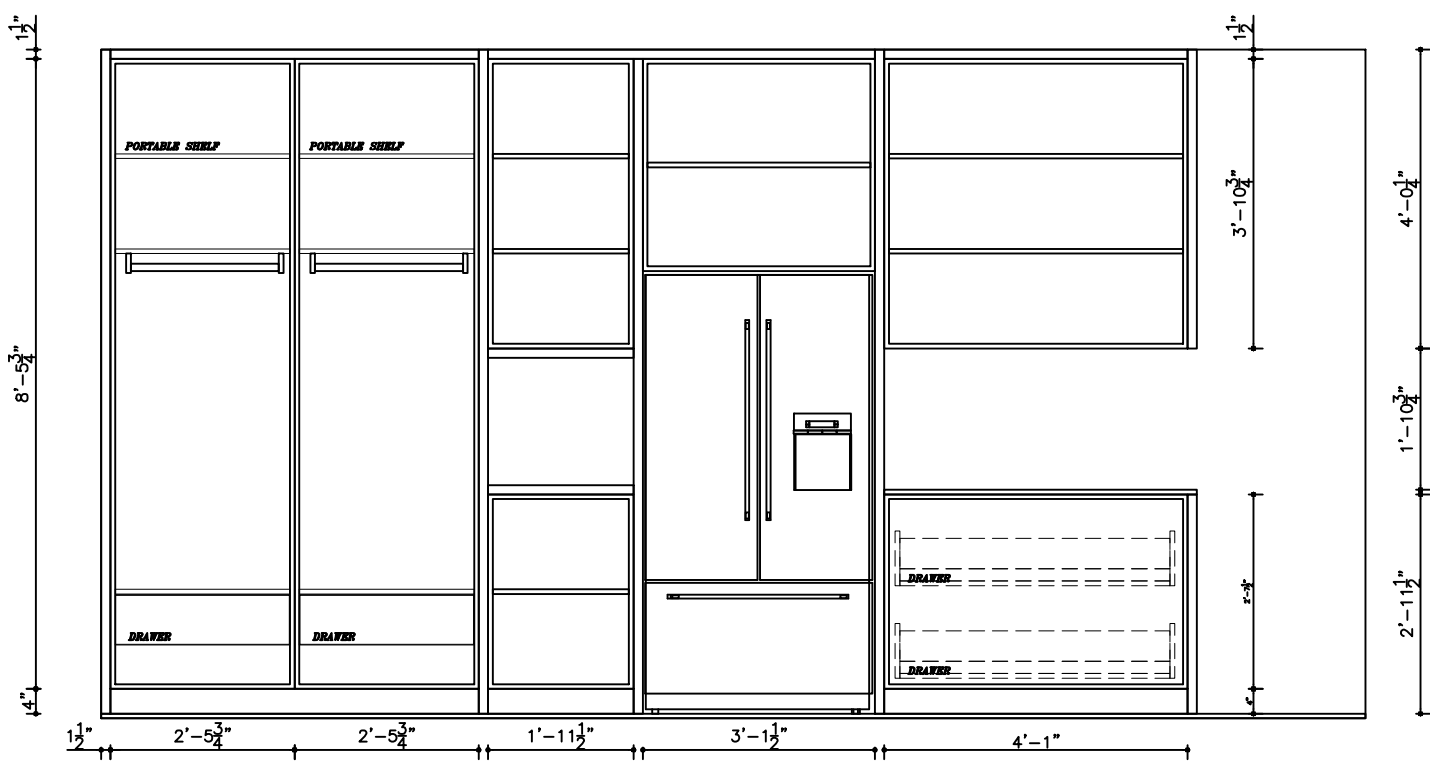

VIEW A



PROJECT TITLE:
11 BROOKMOUNT RD

TITLE:
MAIN FLOOR KITCHEN

All dimensions are subject to verification and adjustment on jobsite to fit job condition.

PRODUCED BY:
N.M

SIGN&DATE:

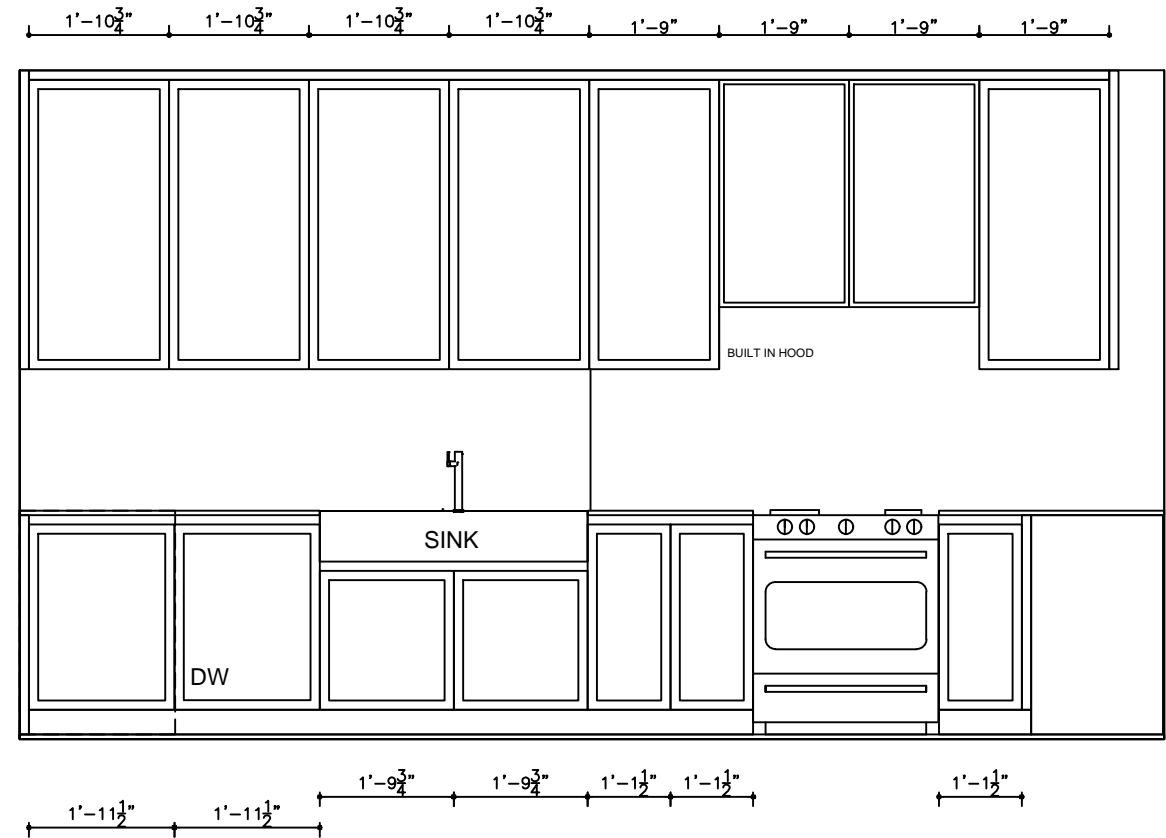
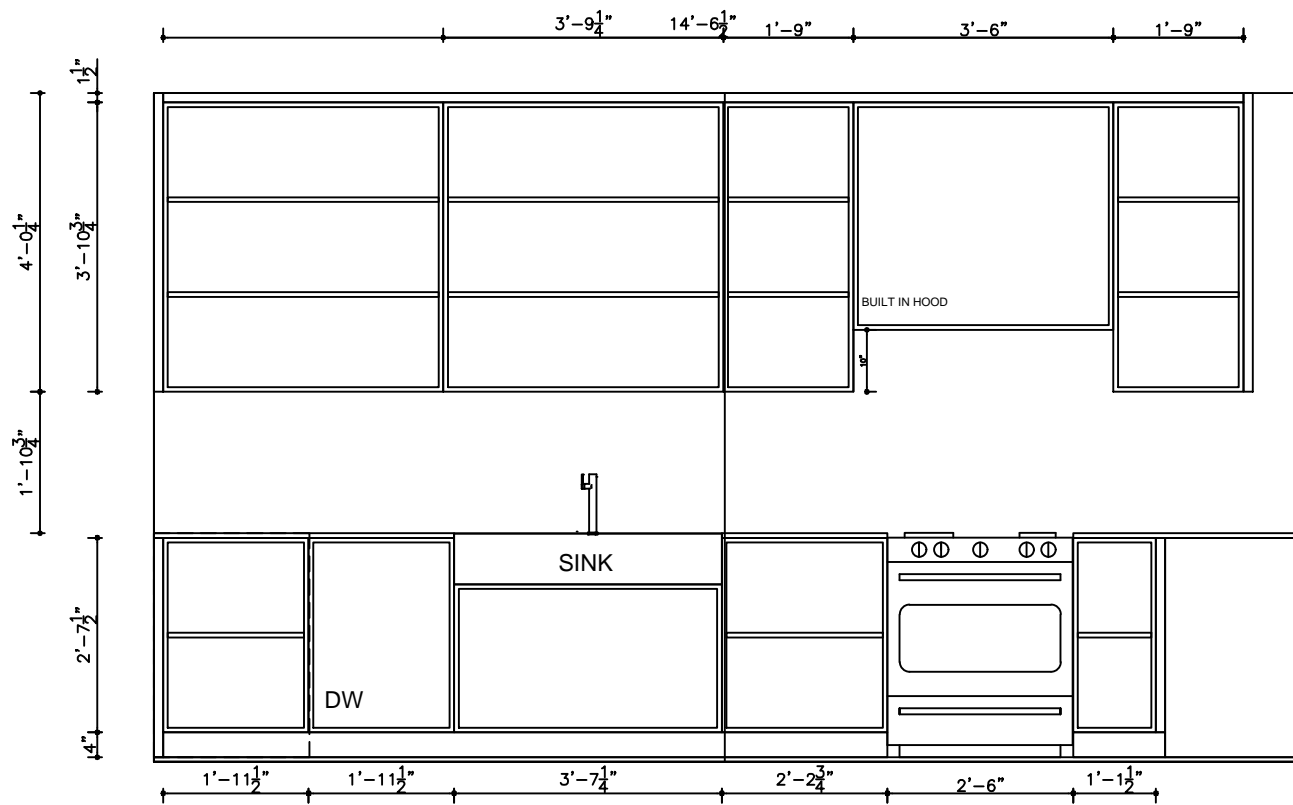

VIEW B



PROJECT TITLE:
11 BROOKMOUNT RD

TITLE:
MAIN FLOOR KITCHEN

All dimensions are subject to verification and adjustment on jobsite to fit job condition.

PRODUCED BY:
N.M

SIGN&DATE:

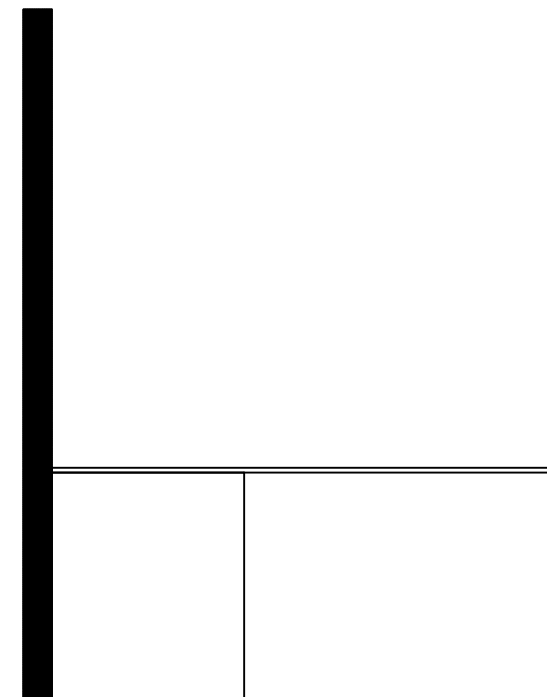
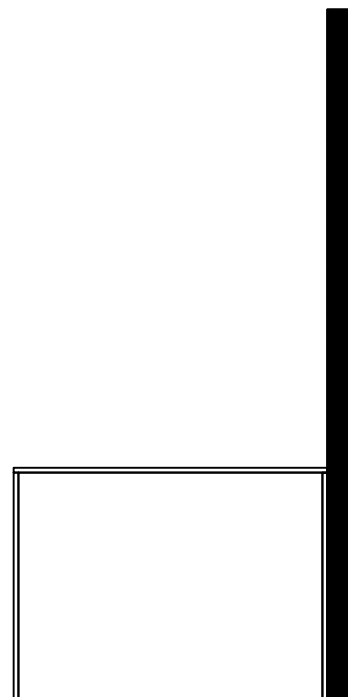
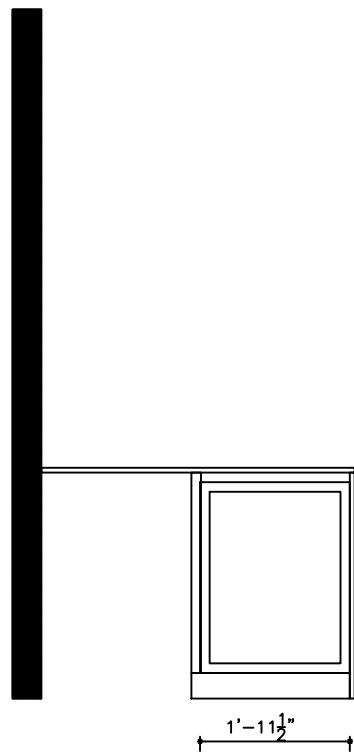
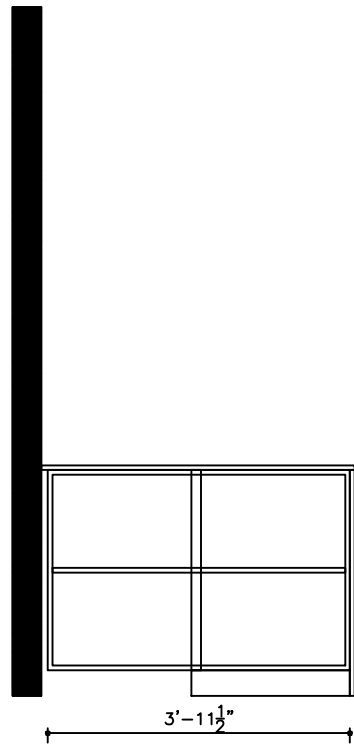

VIEW C-D-E



**PROJECT TITLE:
11 BROOKMOUNT RD**

**TITLE:
MAIN FLOOR KITCHEN**

All dimensions are subject to verification and adjustment on jobsite to fit job condition.

**PRODUCED BY:
N.M**

SIGN&DATE:

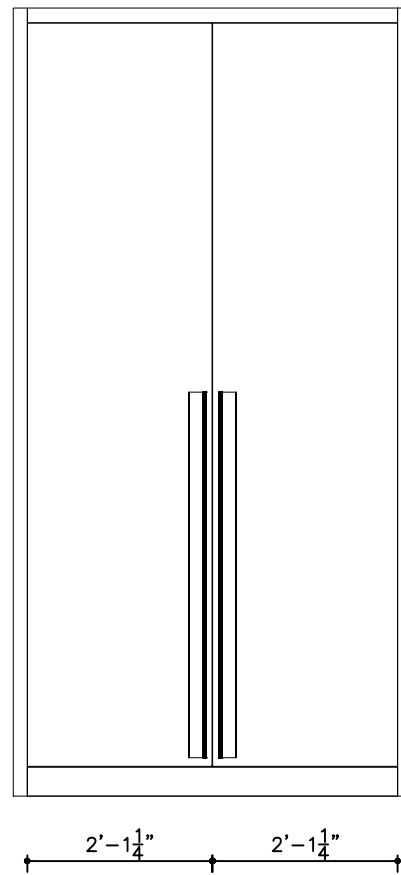
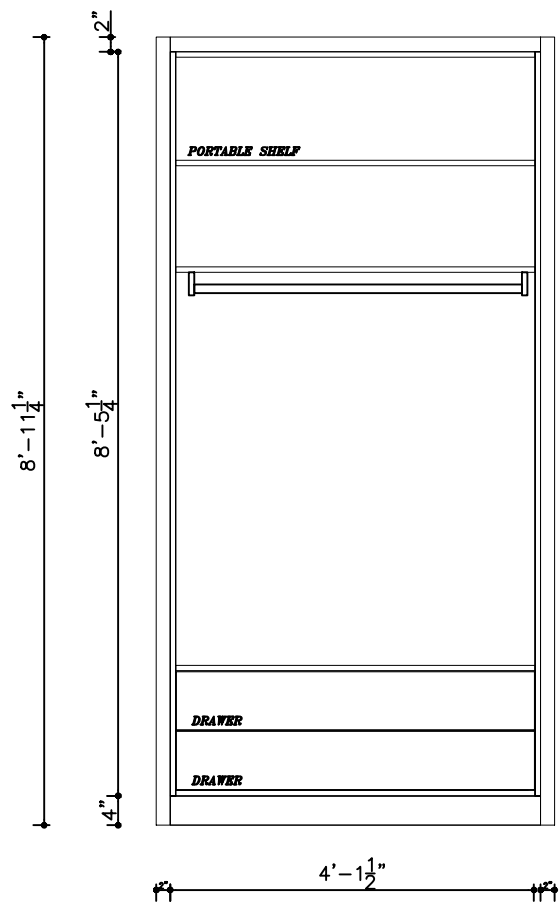

VIEW F



**PROJECT TITLE:
11 BROOKMOUNT RD**

**TITLE:
MAIN FLOOR CLOSET**

All dimensions are subject to verification and adjustment on jobsite to fit job condition.

**PRODUCED BY:
N.M**

SIGN&DATE:

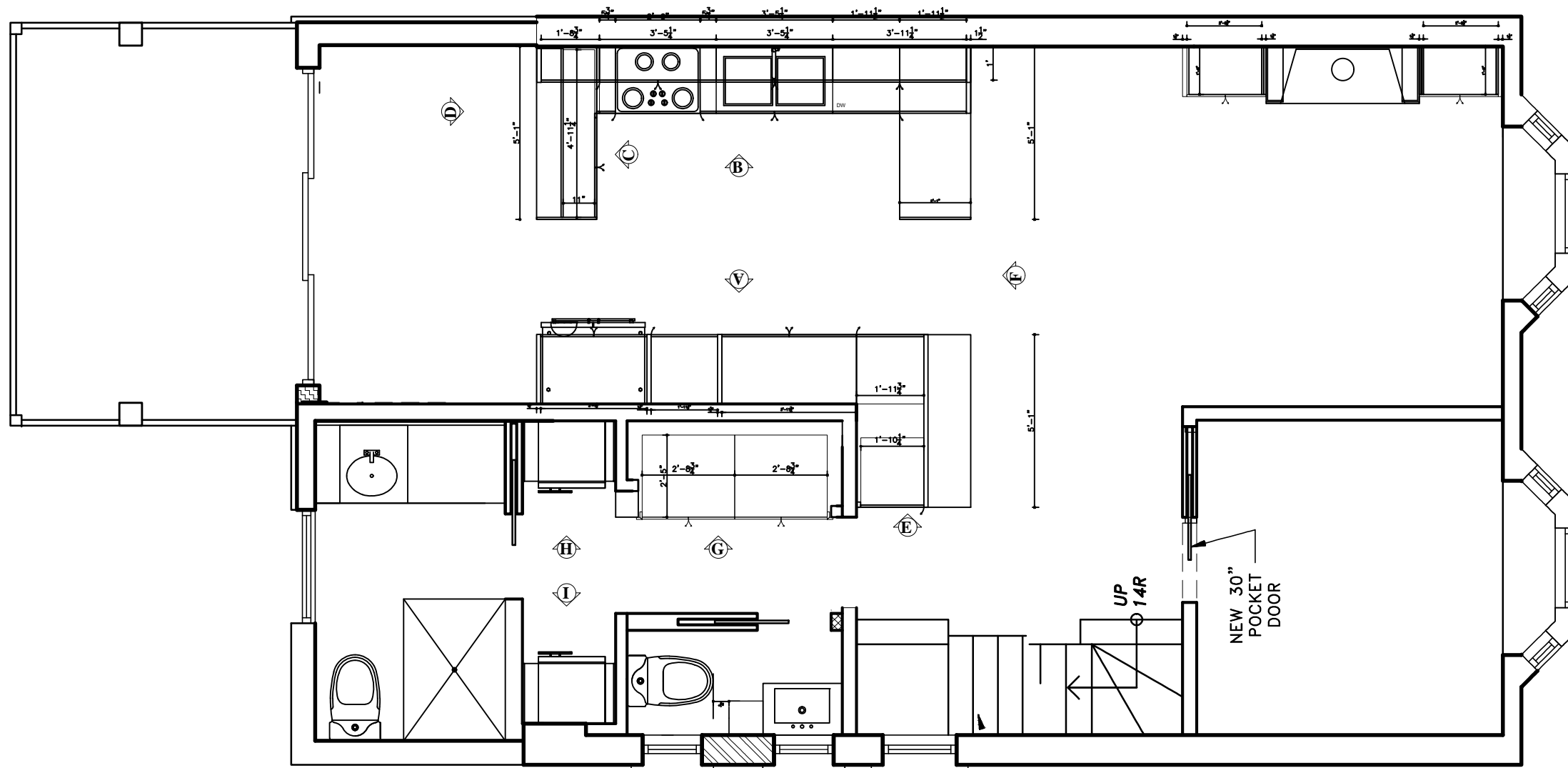

PROJECT TITLE:
11 BROOKMOUNT RD

TITLE:
SECOND FLOOR

All dimensions are subject to verification and adjustment on jobsite to fit job condition.

PRODUCED BY:
N.M

SIGN&DATE:

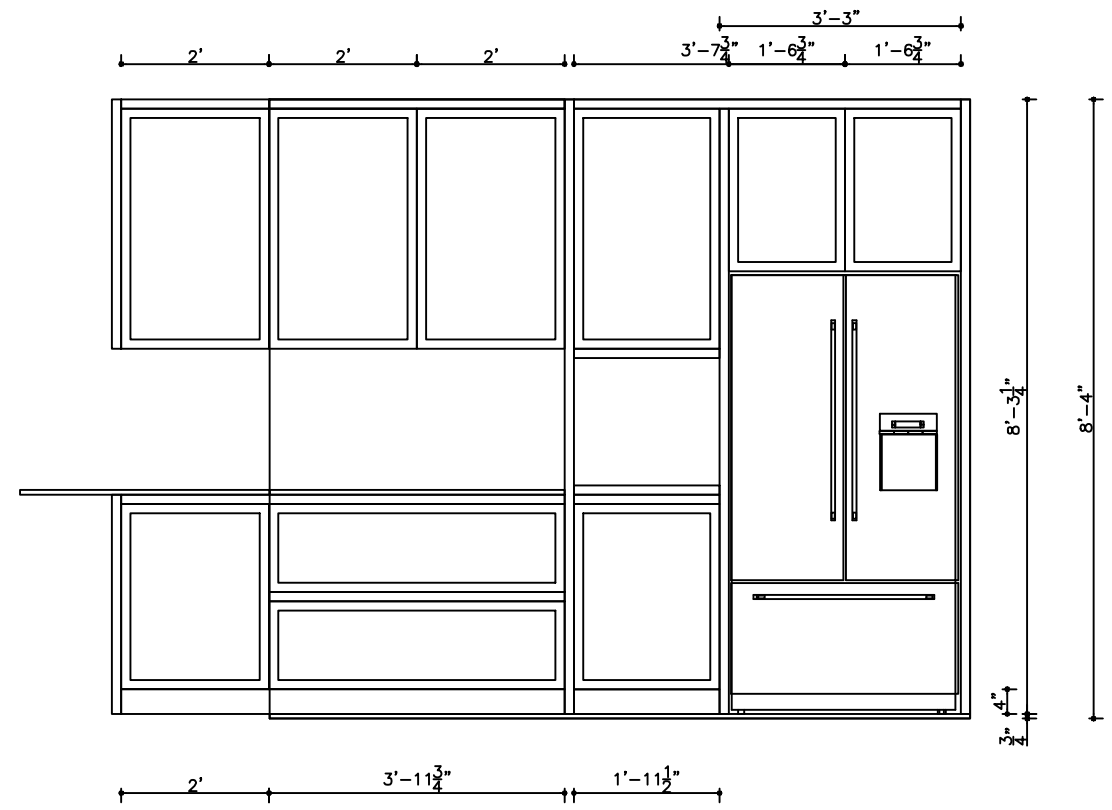
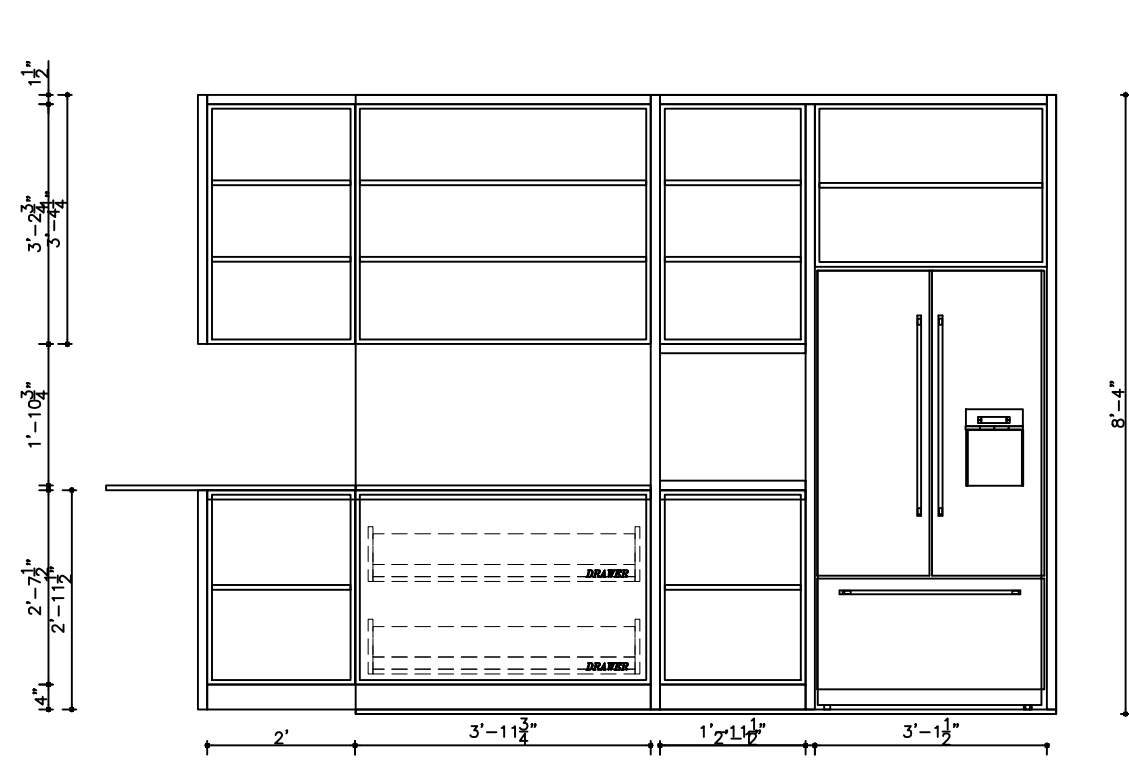

VIEW A



PROJECT TITLE:
 11 BROOKMOUNT RD
TITLE:
 SECOND FLOOR KITCHEN

All dimensions are subject to verification and adjustment on jobsite to fit job condition.

PRODUCED BY:
 N.M
SIGN&DATE:

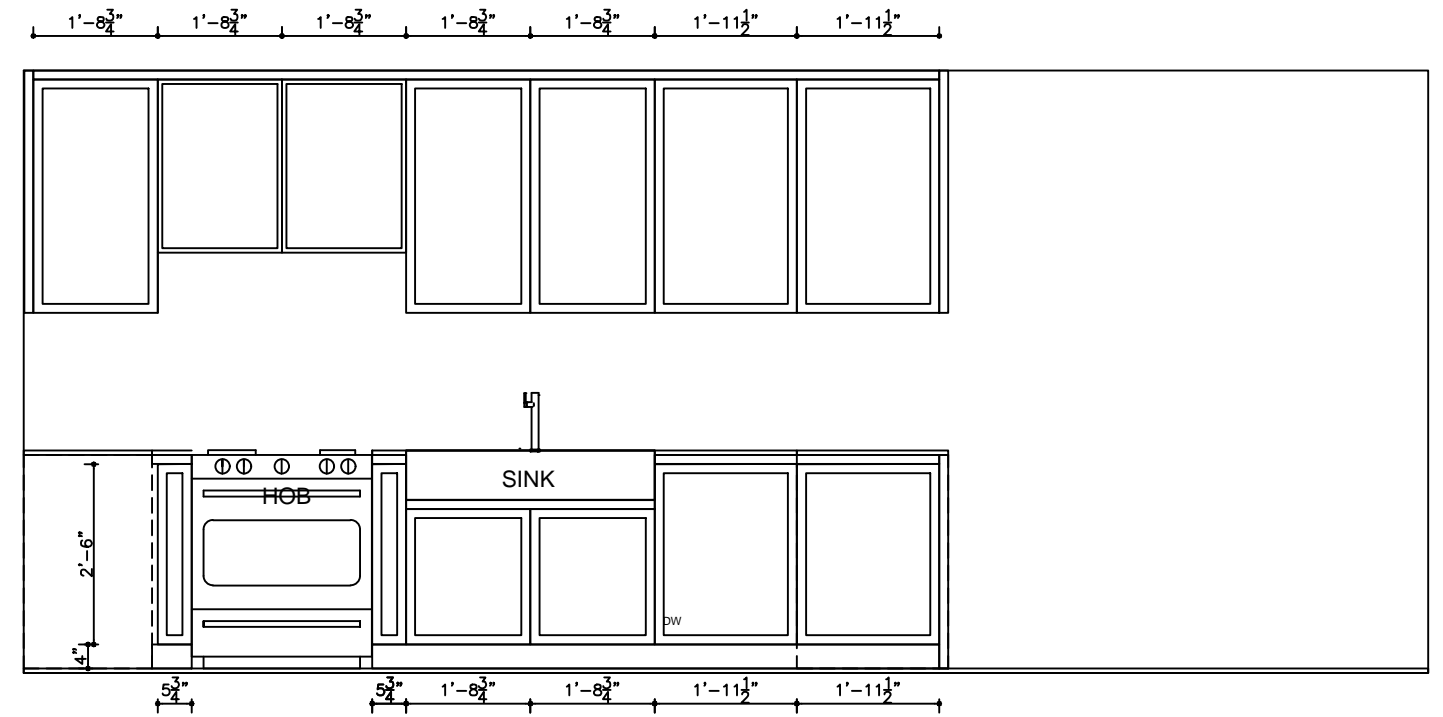
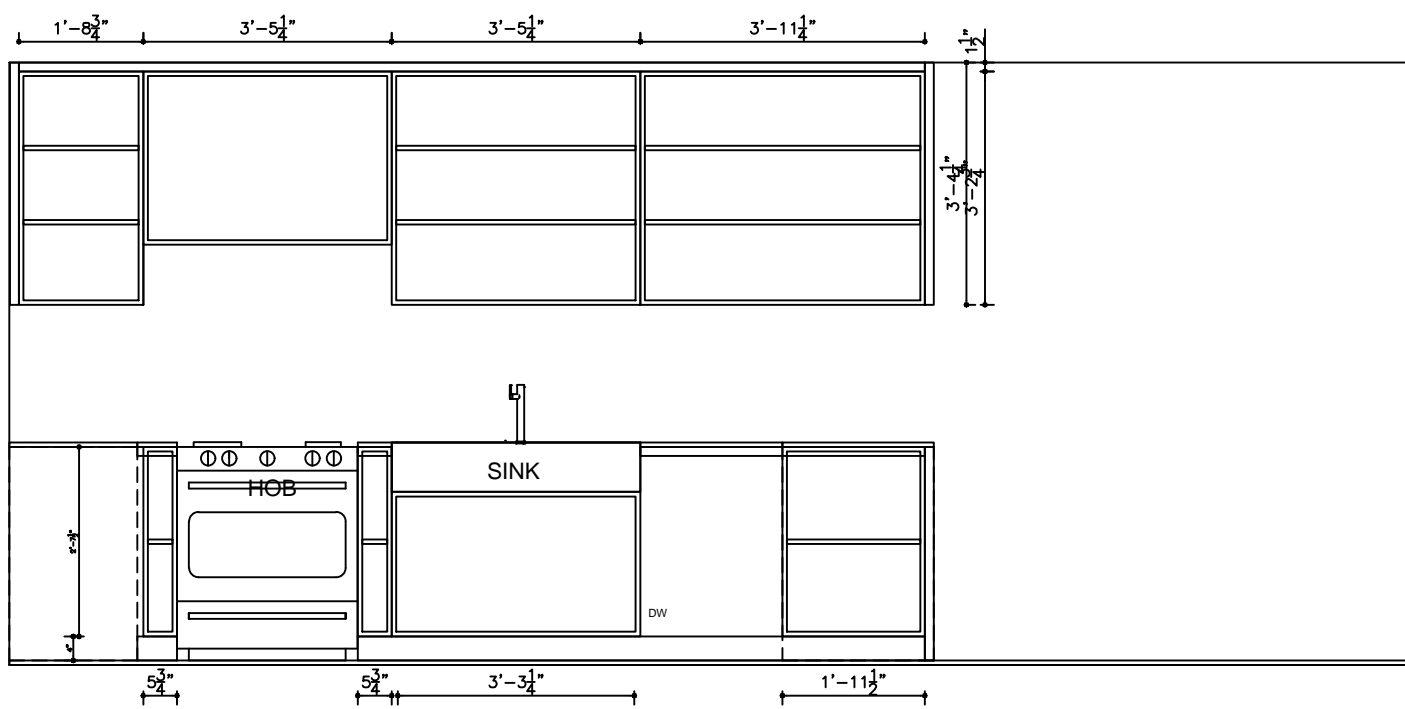

VIEW B



PROJECT TITLE:
11 BROOKMOUNT RD

TITLE:
SECOND FLOOR KITCHEN

All dimensions are subject to verification and adjustment on jobsite to fit job condition.

PRODUCED BY:
N.M

SIGN&DATE:

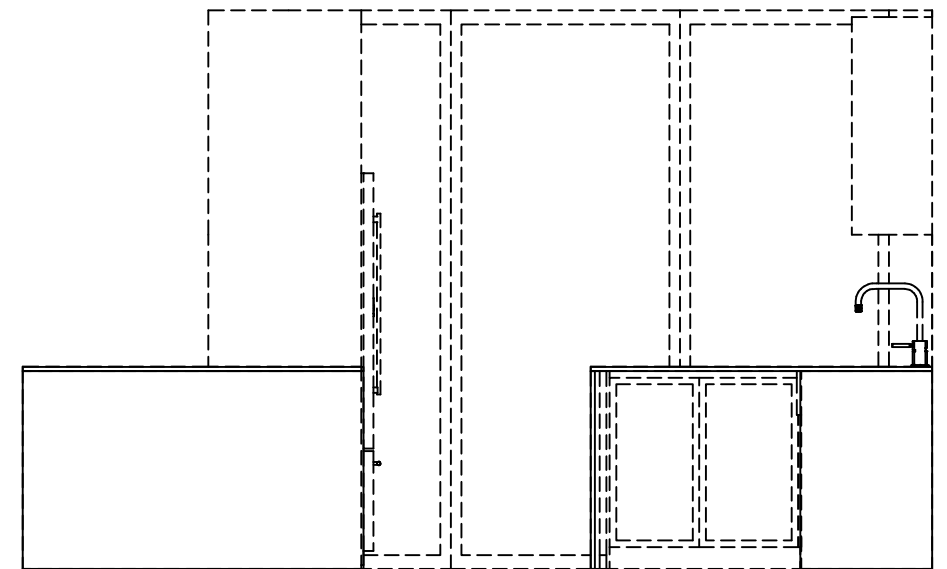
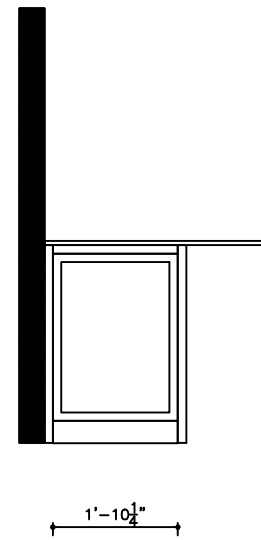
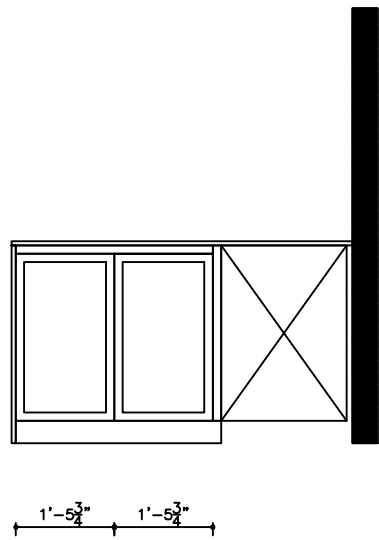
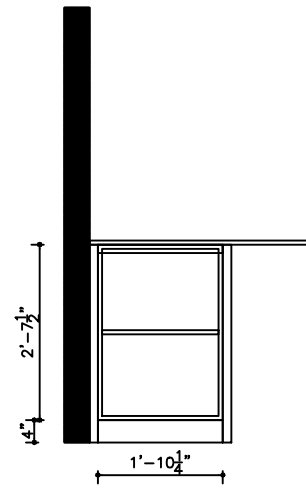
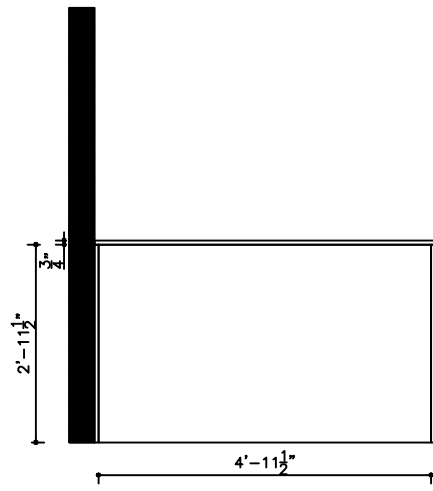
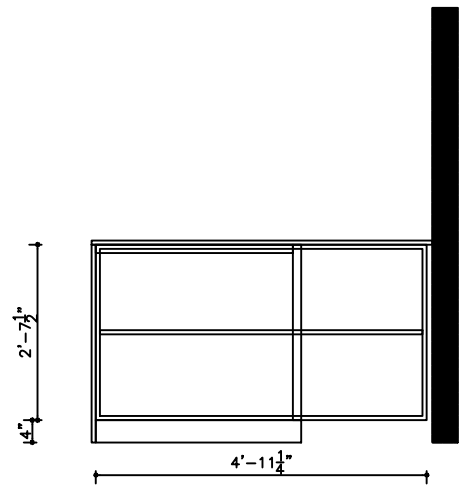

VIEW C-D-E-F



PROJECT TITLE:
11 BROOKMOUNT RD

TITLE:
SECOND FLOOR KITCHEN

All dimensions are subject to verification and adjustment on jobsite to fit job condition.

PRODUCED BY:
N.M

SIGN&DATE:

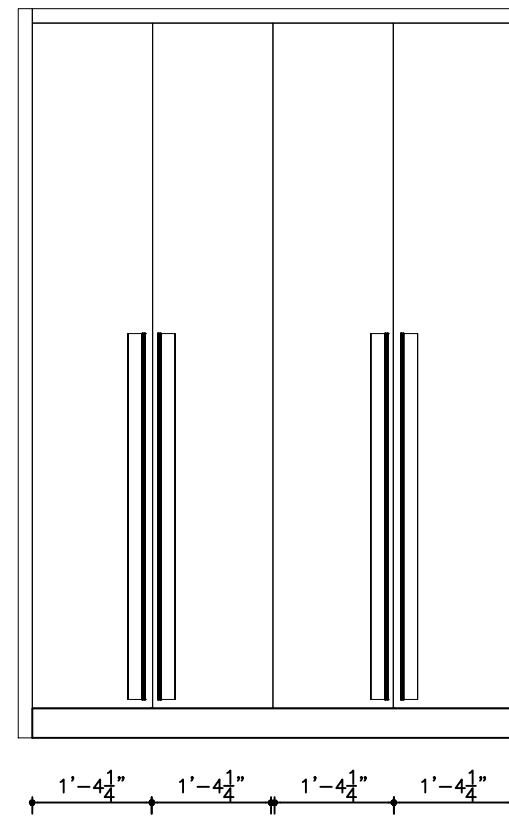
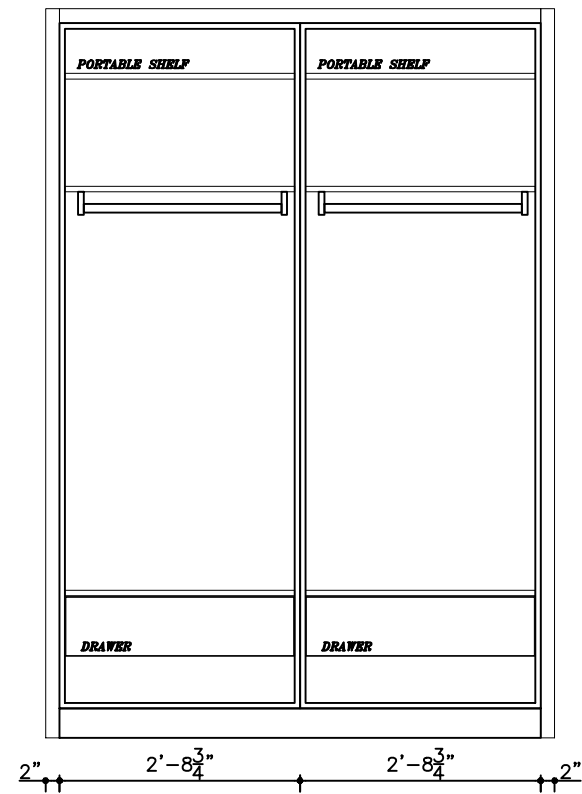

VIEW G



PROJECT TITLE:
11 BROOKMOUNT RD

TITLE:
SECOND FLOOR CLOSET

All dimensions are subject to verification and adjustment on jobsite to fit job condition.

PRODUCED BY:
N.M

SIGN&DATE:

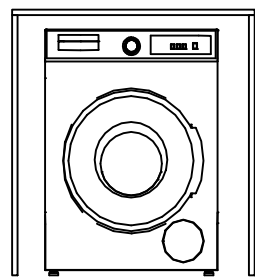
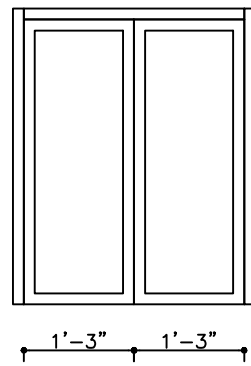
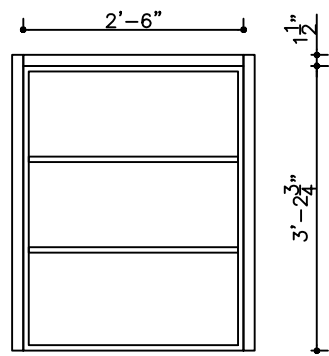

DRYER

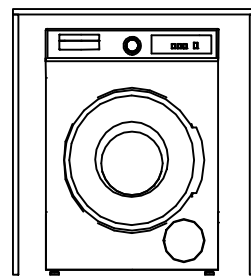

DRYER

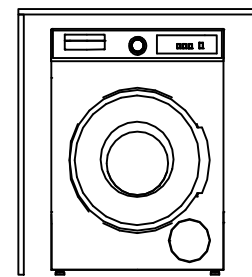
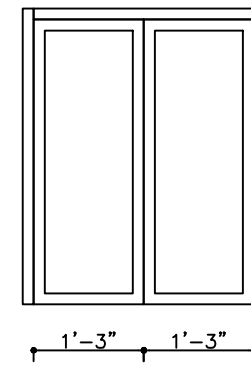
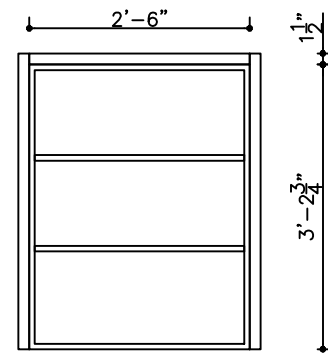

WASHER

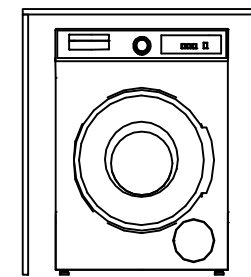

WASHER

TOP LOAD WASHER

VIEW H-I



PROJECT TITLE:
11 BROOKMOUNT RD

TITLE:
SECOND FLOOR D/W

All dimensions are subject to verification and adjustment on jobsite to fit job condition.

PRODUCED BY:
N.M

SIGN&DATE:

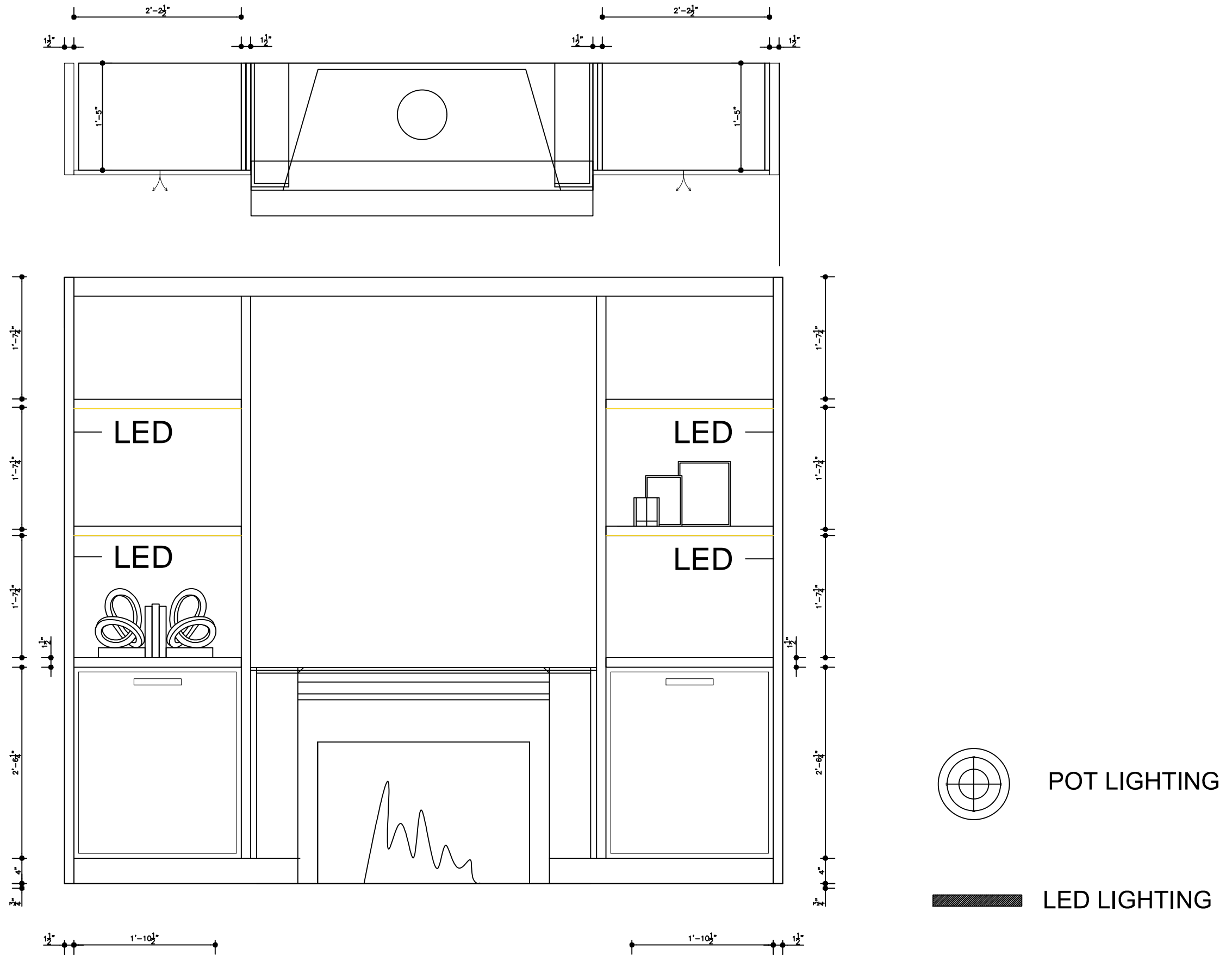

PROJECT TITLE:
11 BROOKMOUNT RD

TITLE:
TV WALL DESIGN

All dimensions are subject to verification and adjustment on jobsite to fit job condition.

PRODUCED BY:
N.M

SIGN&DATE:

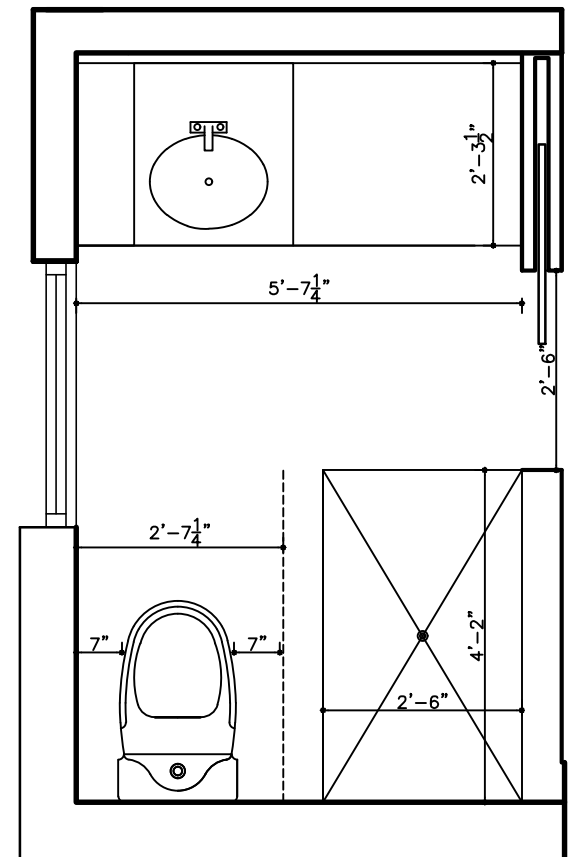
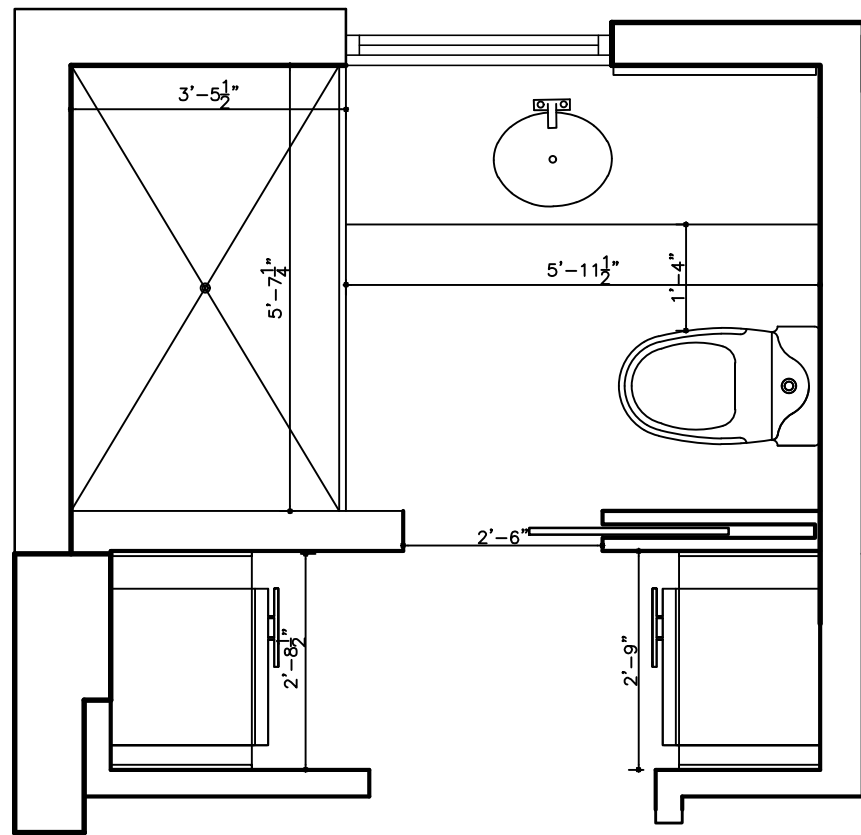
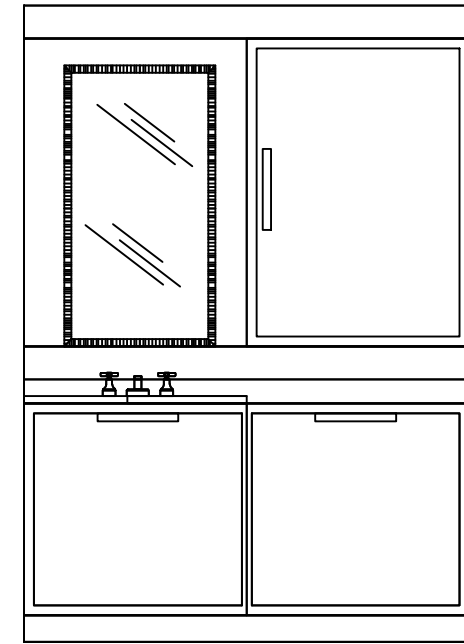
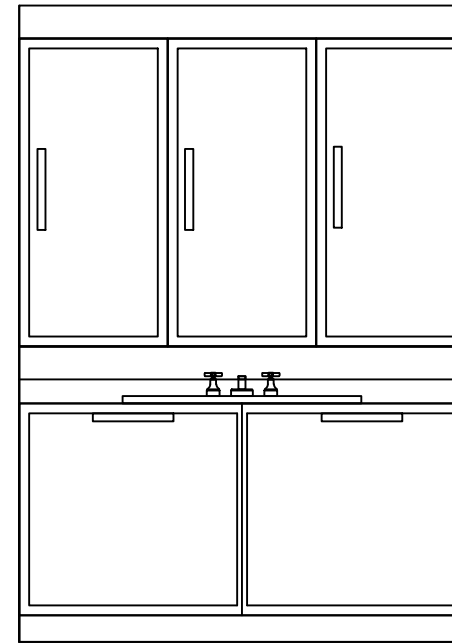
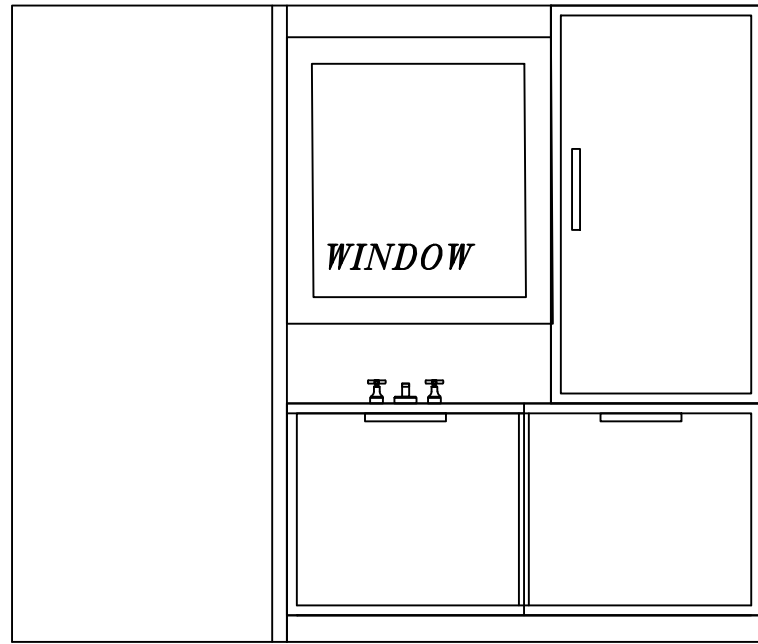

TWO DIFFERENT DESIGN



**PROJECT TITLE:
11 BROOKMOUNT RD**

**TITLE:
SECOND FLOOR BATHROOM**

All dimensions are subject to verification and adjustment on jobsite to fit job condition.

**PRODUCED BY:
N.M**

SIGN&DATE:

