

PROJECT TITLE:
173 MINEOLA ROAD EAST

TITLE:
FOYER DESIGN

All dimensions are subject to verification
and adjustment on jobsite to fit job
condition.

PRODUCED BY:
N.M

SIGN&DATE:

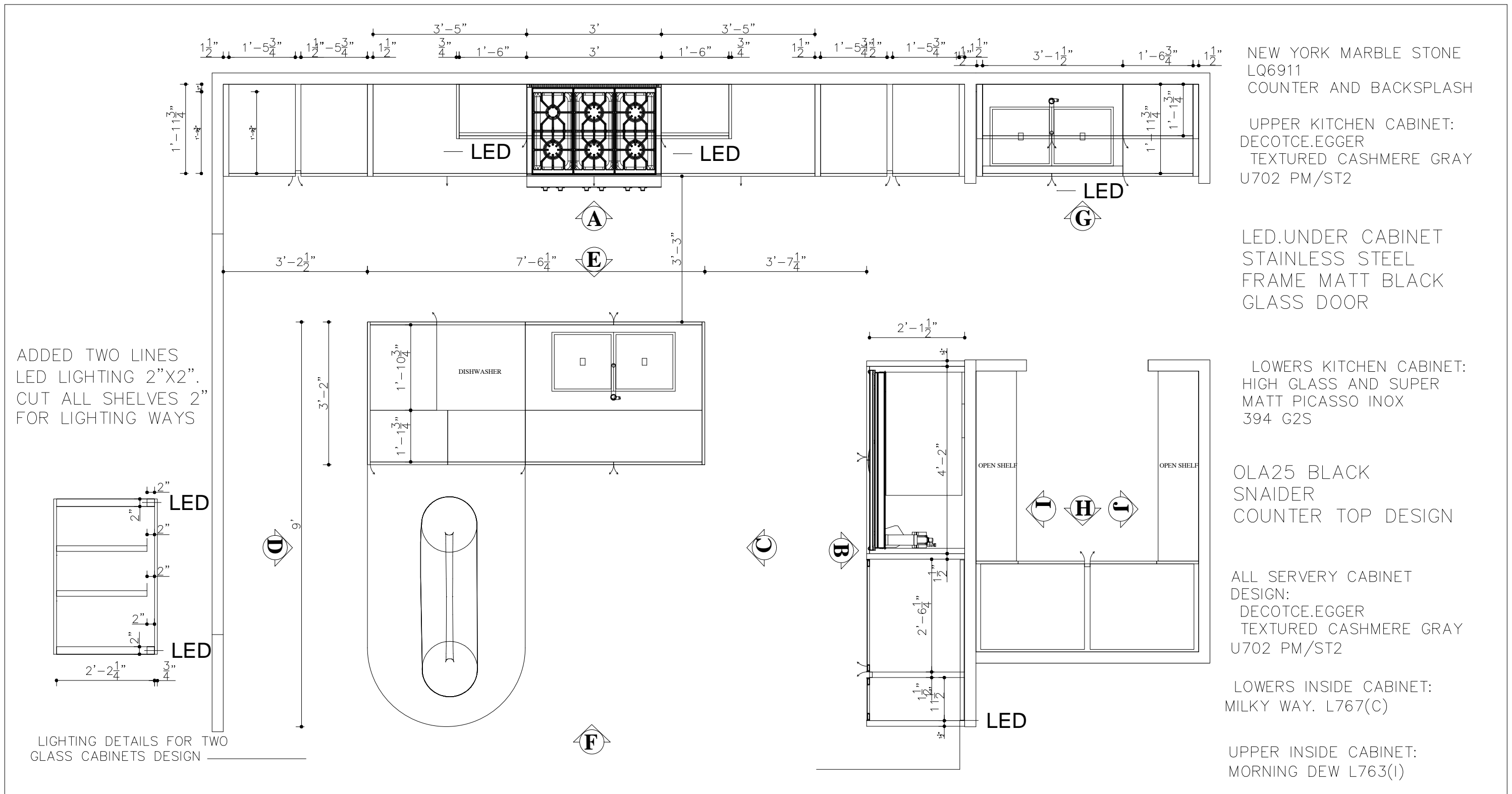

KITCHEN PLAN



PROJECT TITLE:
173 MINEOLA ROAD EAST

TITLE:
KITCHEN DESIGN

All dimensions are subject to verification
and adjustment on jobsite to fit job
condition.

PRODUCED BY:
N.M

SIGN&DATE:

THE BRAND OF APPLIANCE IS [WOLF]

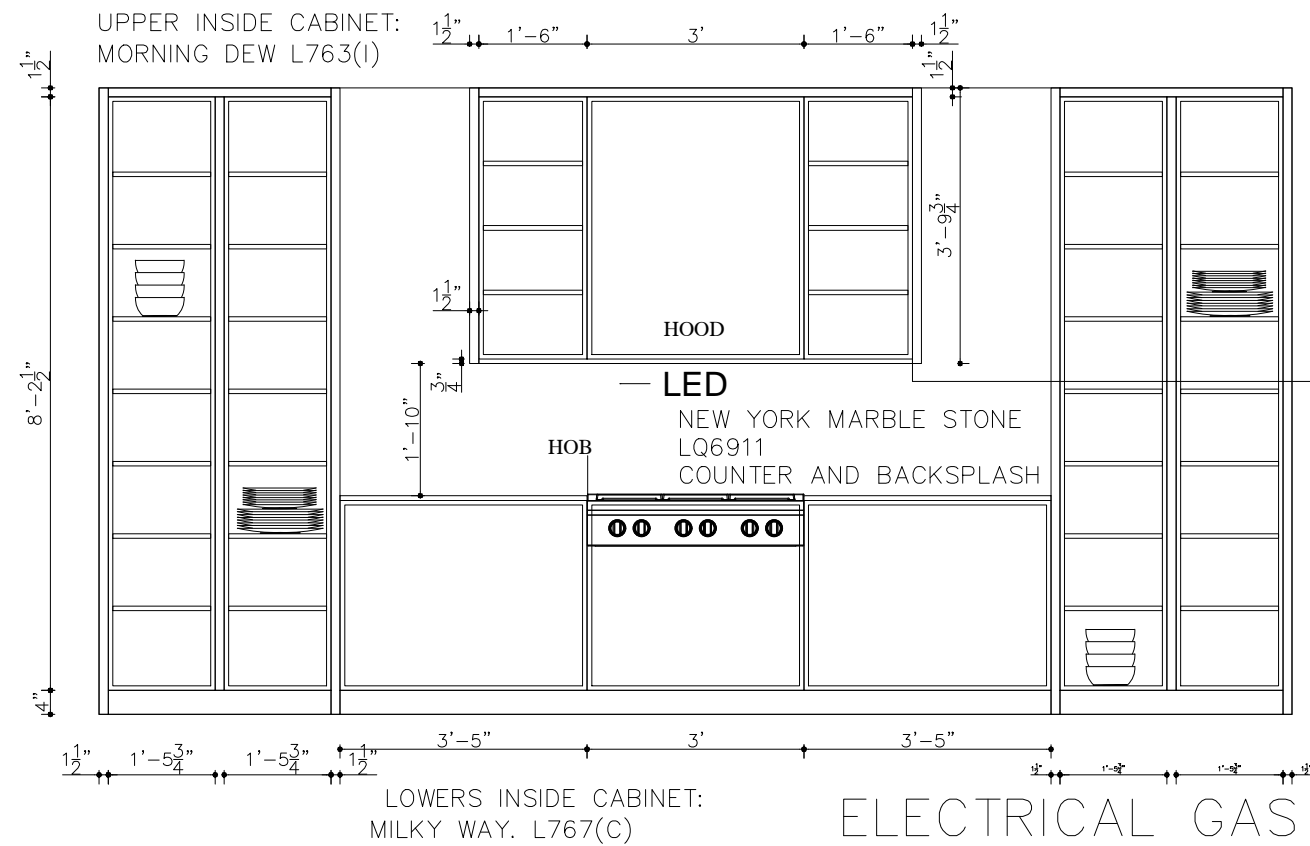

ELECTRICAL GAS MODEL: SRT364G

VIEW A



PROJECT TITLE:
173 MINEOLA ROAD EAST

TITLE:
KITCHEN DESIGN

All dimensions are subject to verification and adjustment on jobsite to fit job condition.

PRODUCED BY:
N.M

SIGN&DATE:

<p>COUNTERTOP TOBE NEW YORK MARBLE STONE VEIN LQ6911 MATCHED</p> <p>OLA25 BLACK SNAIDER</p> <p>LED.UNDER CABINET</p>	<p>NEW YORK MARBLE STONE LQ6911</p> <p>COUNTERTOP TOBE NEW YORK MARBLE STONE VEIN LQ6911 MATCHED</p> <p>OLA25 BLACK SNAIDER</p> <p>LED.UNDER CABINET</p>	<p>LOWERS INSIDE CABINET: MILKY WAY. L767(C)</p> <p>PULLOUT GARBAGE</p> <p>REV-A-SHELF DOUBLE RECYCLING CENTER</p> <p>NEW YORK MARBLE STONE LQ6911</p> <p>LOWERS KITCHEN CABINET AND PANELREADY: HIGH GLASS AND SUPER MATT PICASSO INOX 394 G2S</p> <p>HIDDEN HANDLE WOOD GOLLA "L" SHAPE PROFILE BLACK.70010050410900</p>	<p>LOWERS INSIDE CABINET: MILKY WAY. L767(C)</p> <p>FOUR PANELREADY CABINET FOR DESIGN</p> <p>NEW YORK MARBLE STONE LQ6911</p> <p>FOUR PANELREADY CABINET</p> <p>HIDDEN HANDLE WOOD GOLLA "L" SHAPE PROFILE BLACK.70010050410900</p> <p>LOWERS KITCHEN CABINET: HIGH GLASS AND SUPER MATT PICASSO INOX 394 G2S</p>
<p>VIEW C</p>	<p>VIEW D</p>	<p>VIEW E</p>	<p>VIEW F</p>
	<p>PROJECT TITLE: 173 MINEOLA ROAD EAST</p> <p>TITLE: KITCHEN DESIGN</p>	<p>All dimensions are subject to verification and adjustment on jobsite to fit job condition.</p>	<p>PRODUCED BY: N.M</p> <p>SIGN&DATE:</p>

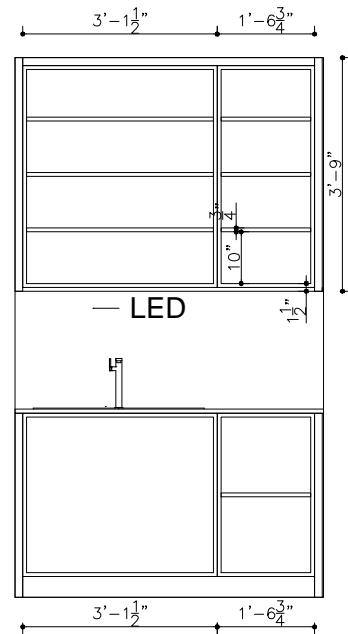

ADDED 3/4" THICKNESS FOR LED LINER
 UPPER AND LOWER INSIDE CABINET: MORNING DEW L763(I)

HIDDEN HANDLE WOOD
 GOLA "L" SHAPE PROFILE
 BLACK.70010050410900



NEW YORK MARBLE STONE
 LQ6911
 COUNTER AND BACKSPLASH

PULL OUT CABINET STORAGE
 REV-A-SHELF SINGLE RECYCLING CENTER

ALL SERVERY CABINET
 DESIGN:
 DECOTCE.EGGER
 TEXTURED CASHMERE GRAY
 U702 PM/ST2

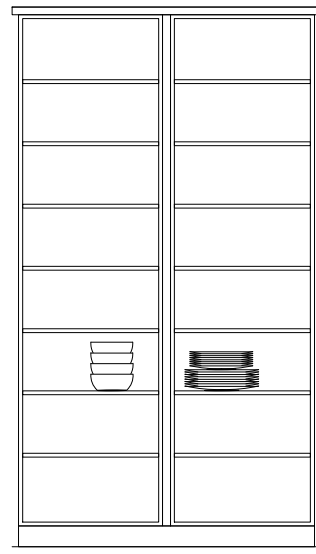

UPPER INSIDE CABINET:
 MORNING DEW L763(I)

LED.UNDER CABINET
 UNDER ALL SHELVES

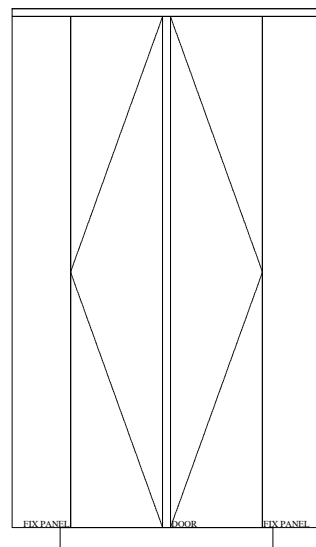

HIDDEN HANDLE:
 MORNING DEW L763(I)

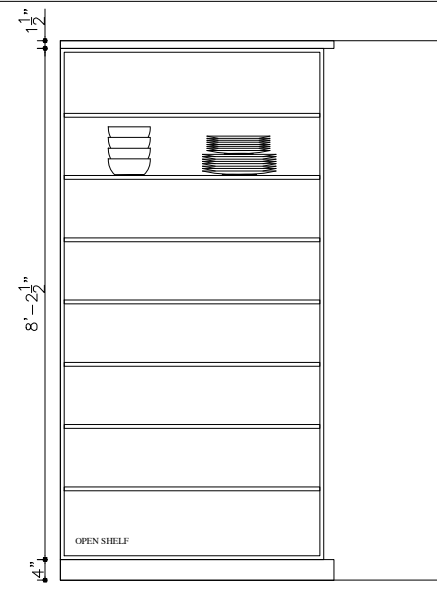

UPPER INSIDE CABINET:
 MORNING DEW L763(I)

LED.UNDER CABINET
 UNDER ALL SHELVES

VIEW I

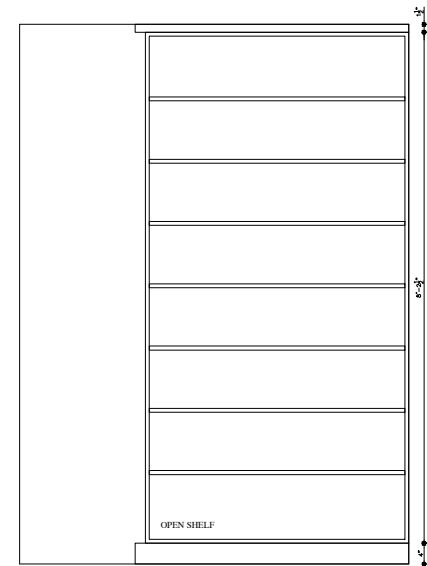

UPPER INSIDE CABINET:
 MORNING DEW L763(I)

LED.UNDER CABINET
 UNDER ALL SHELVES

VIEW G

VIEW H

VIEW J



PROJECT TITLE:
 173 MINEOLA ROAD EAST

TITLE:
 KITCHEN DESIGN

All dimensions are subject to verification
 and adjustment on jobsite to fit job
 condition.

PRODUCED BY:
 N.M

SIGN&DATE:

Plaza Gold metal makeup table featuring a steel frame with a golden tint and tempered wood top.

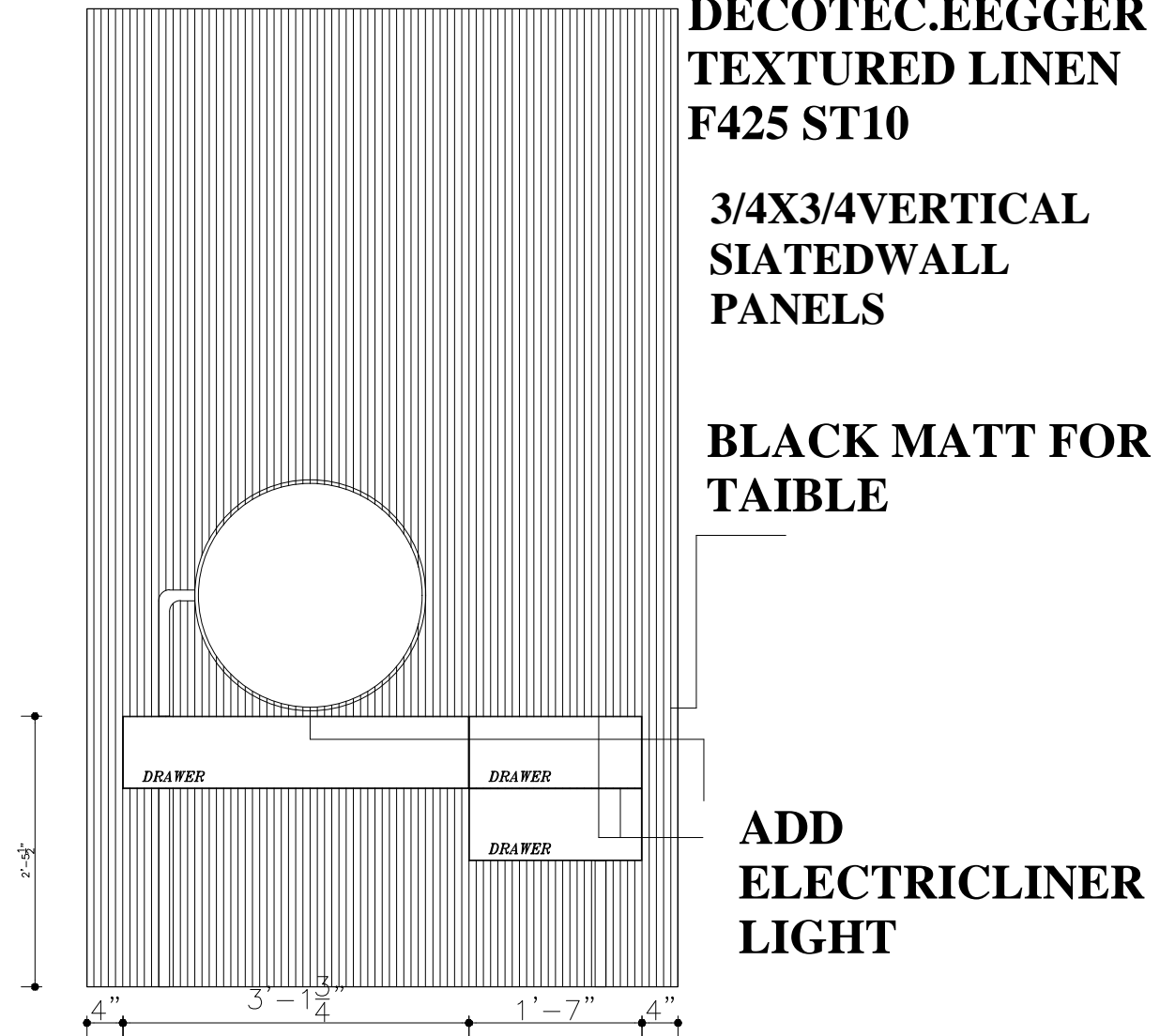
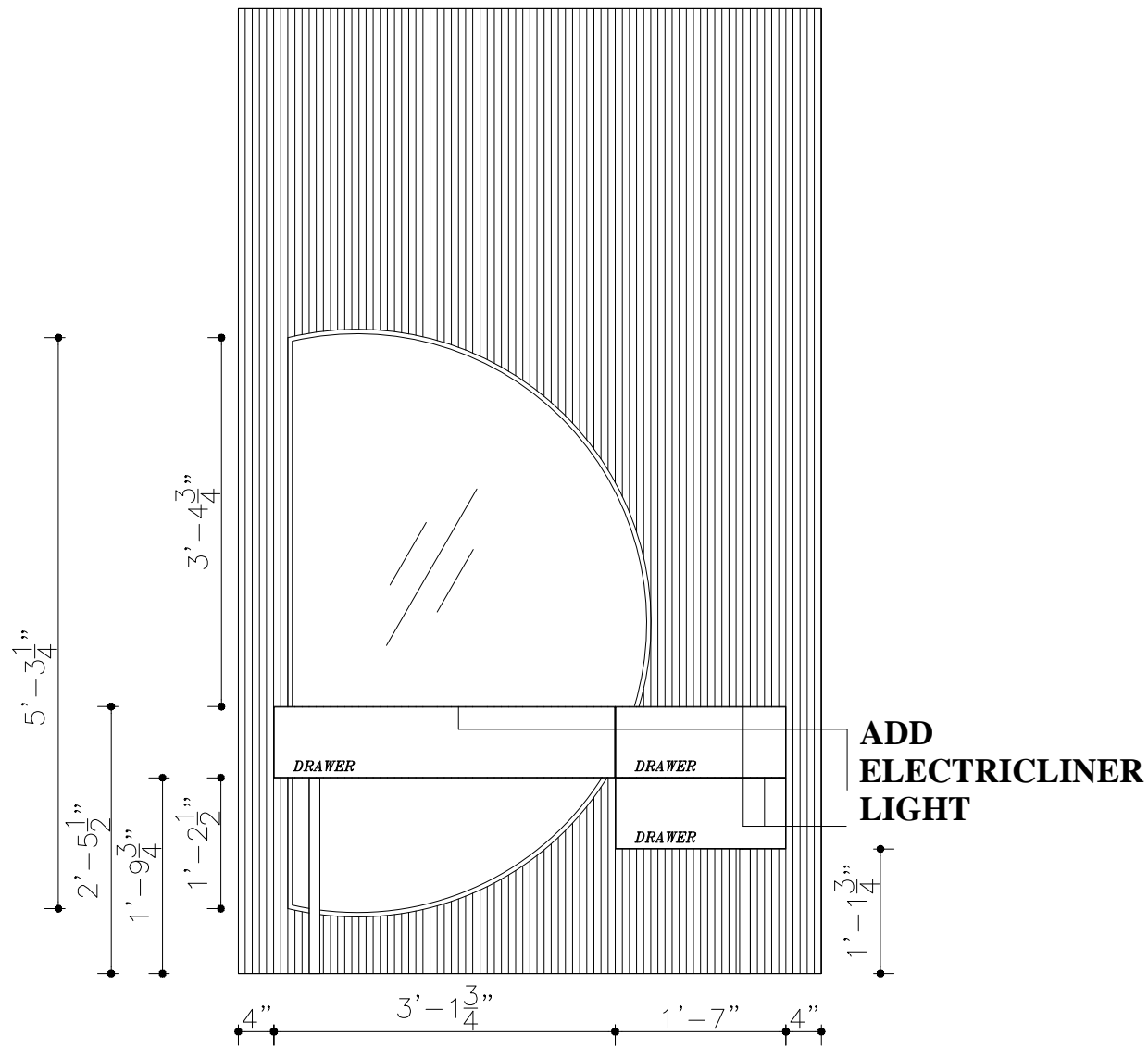

HIDDEN HANDLE WOOD
GOLA "L" SHAPE PROFILE
BLACK.70010050410900

VIEW E



PROJECT TITLE:
173 MINEOLA ROAD EAST

TITLE:
WALK IN CLOSET

All dimensions are subject to verification and adjustment on jobsite to fit job condition.

PRODUCED BY:
N.M

SIGN&DATE:

PORTABLE SHELVES

HIDDEN HANDLE WOOD
 GOLLA "L" SHAPE PROFILE
 BLACK.70010050410900

DECOTEC.EEGGER
TEXTURED LINEN
F425 ST10

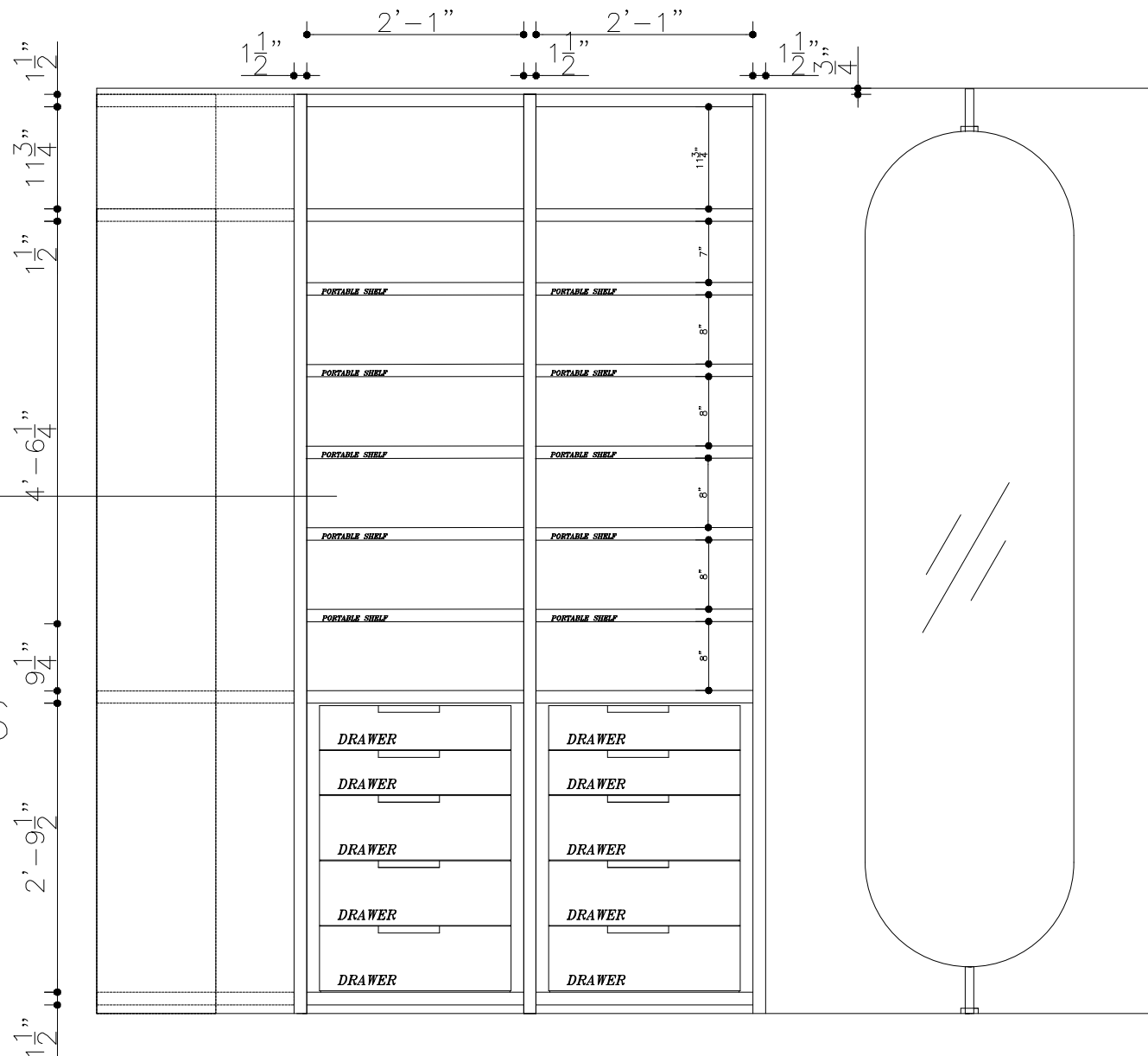

OVAL
 GOLDMETAL
 MIRROR
 FRAMA

VIEW D



PROJECT TITLE:
 173 MINEOLA ROAD EAST

TITLE:
 WALK IN CLOSET

All dimensions are subject to verification
 and adjustment on jobsite to fit job
 condition.

PRODUCED BY:
 N.M

SIGN&DATE:

HIDDEN HANDLE WOOD
 GOLA "L" SHAPE PROFILE
 BLACK.70010050410900

DECOTEC.EEGGER
TEXTURED LINEN
F425 ST10

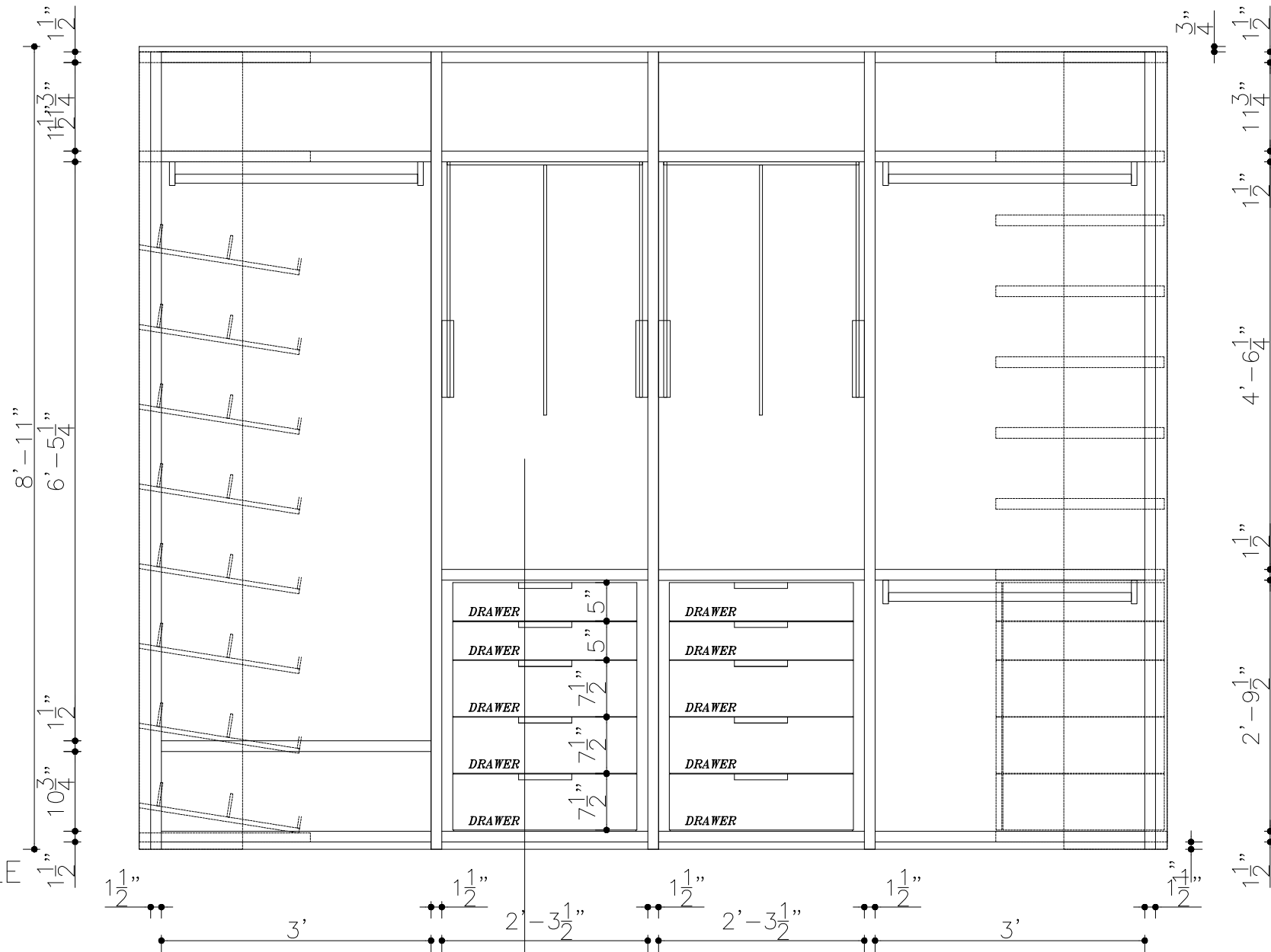

VIEW C



PROJECT TITLE:
 173 MINEOLA ROAD EAST

TITLE:
 WALK IN CLOSET

All dimensions are subject to verification
 and adjustment on jobsite to fit job
 condition.

PRODUCED BY:
 N.M

SIGN&DATE:

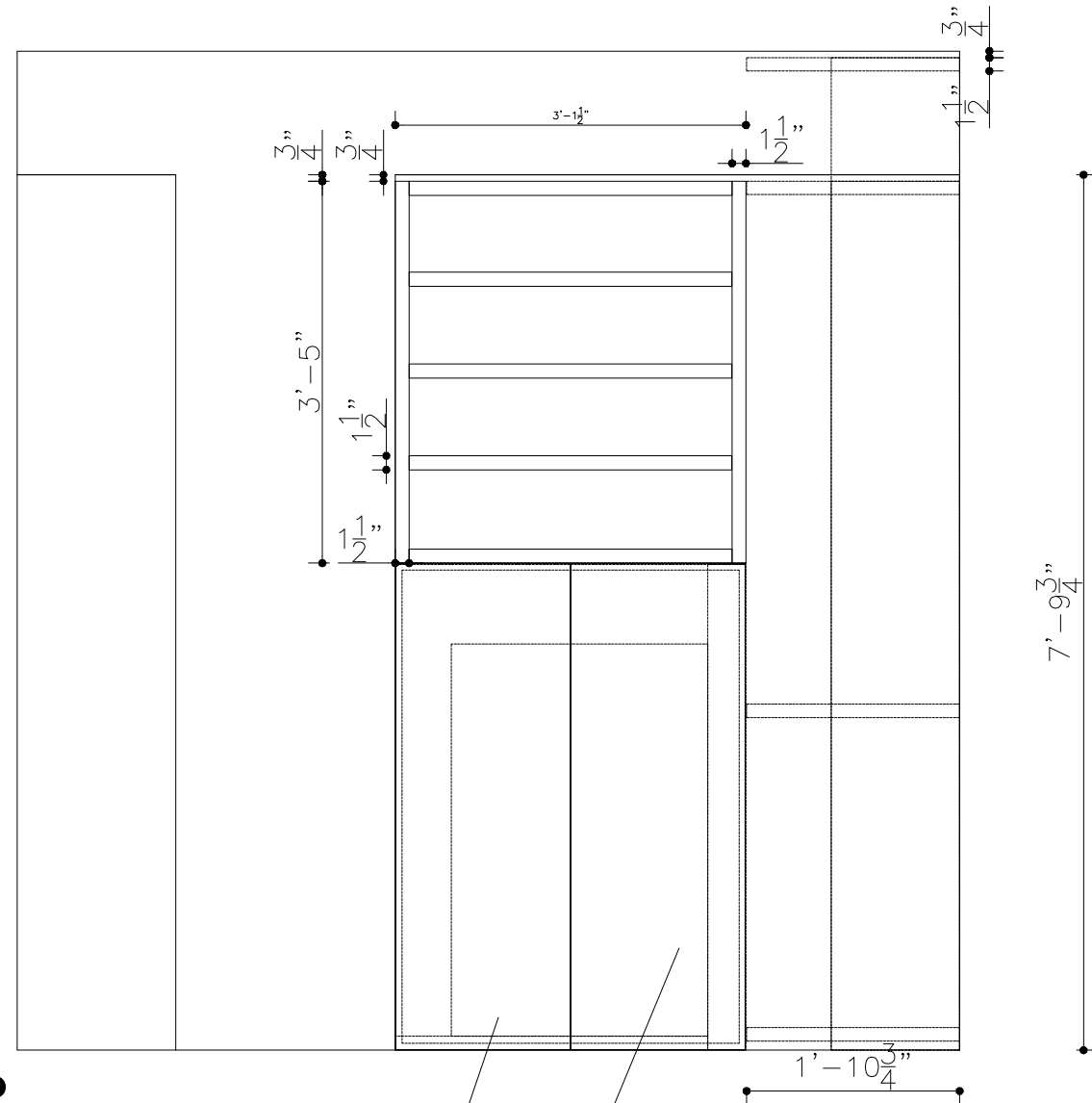

**DECOTEC.EEGGER
TEXTURED LINEN
F425 ST10**

8'-5"
ELECTRICAL
PANEL
ACCESSIBLE

ELECTRICITY BOX
COVERED BY SAME
METERIAL AS A WALL

USE PUSH OPEN
WITH SAFETY
LOCK

VIEW A



PROJECT TITLE:
173 MINEOLA ROAD EAST

TITLE:
WALK IN CLOSET

All dimensions are subject to verification
and adjustment on jobsite to fit job
condition.

PRODUCED BY:
N.M

SIGN&DATE:

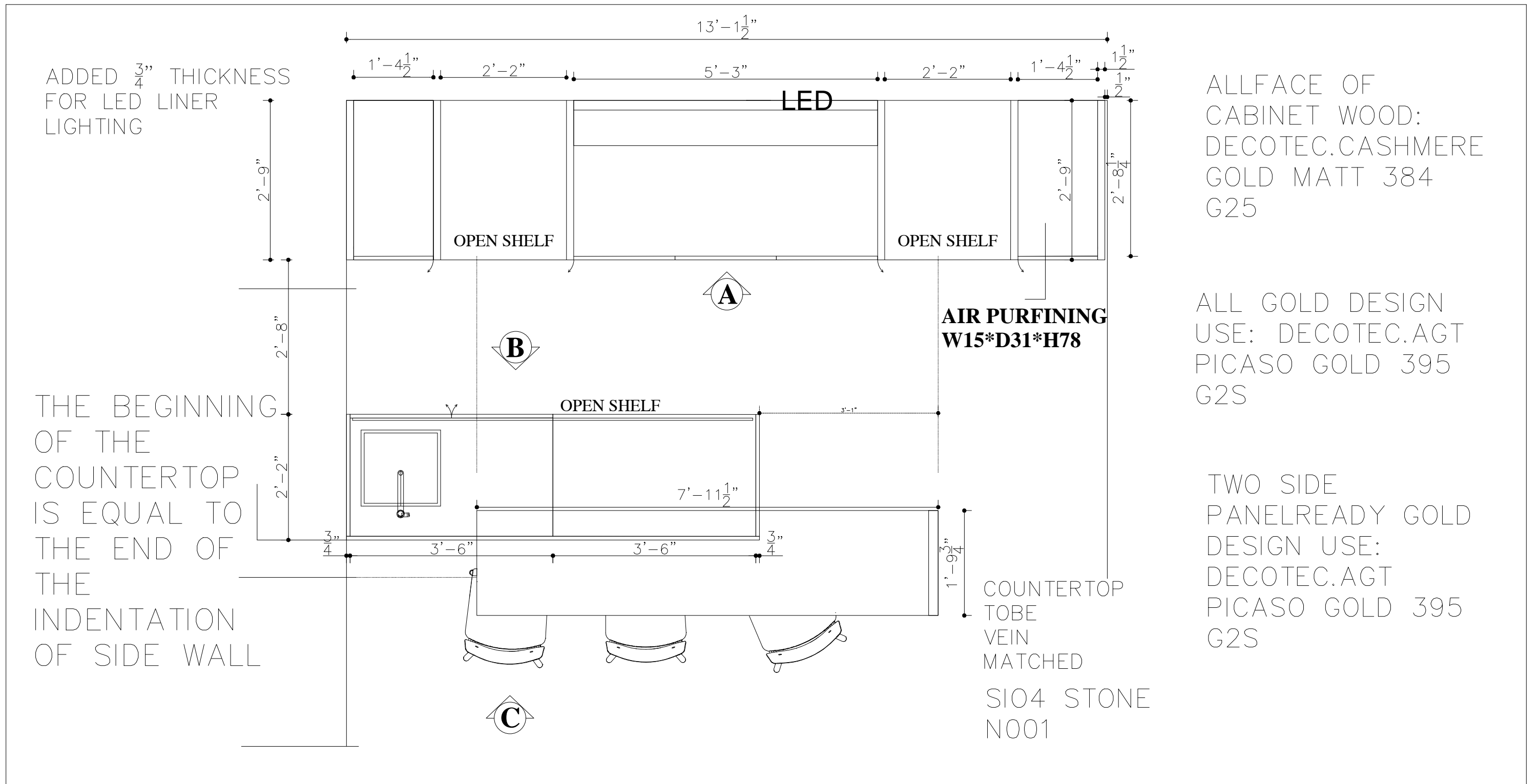

BAR PLAN



PROJECT TITLE:
173 MINEOLA ROAD EAST

TITLE:
BAR DESIGN

All dimensions are subject to verification and adjustment on jobsite to fit job condition.

PRODUCED BY:
N.M

SIGN&DATE:

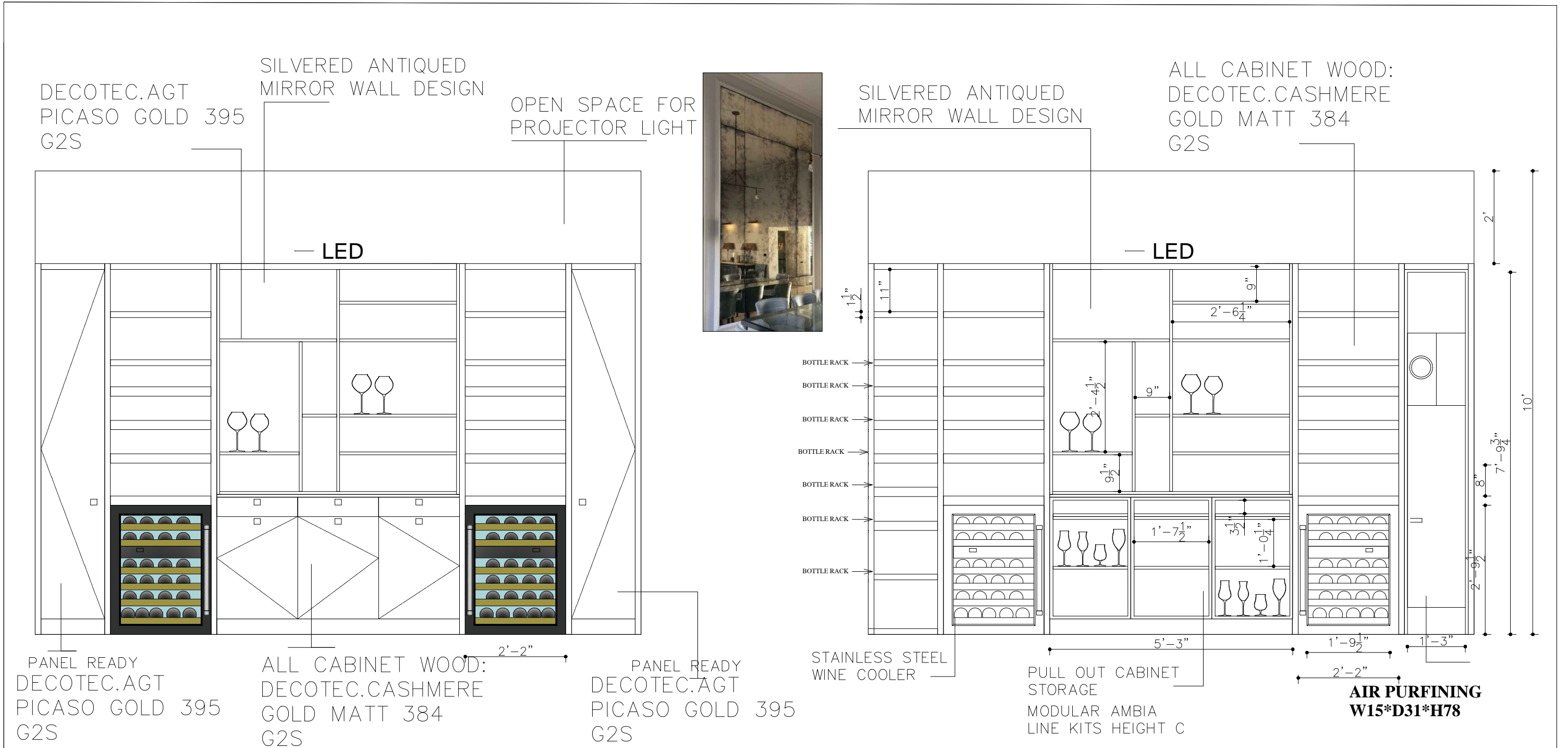

VIEW A



PROJECT TITLE:
173 MINEOLA ROAD EAST

TITLE:
BAR DESIGN

All dimensions are subject to verification and adjustment on jobsite to fit job condition.

PRODUCED BY:
N.M

SIGN&DATE:

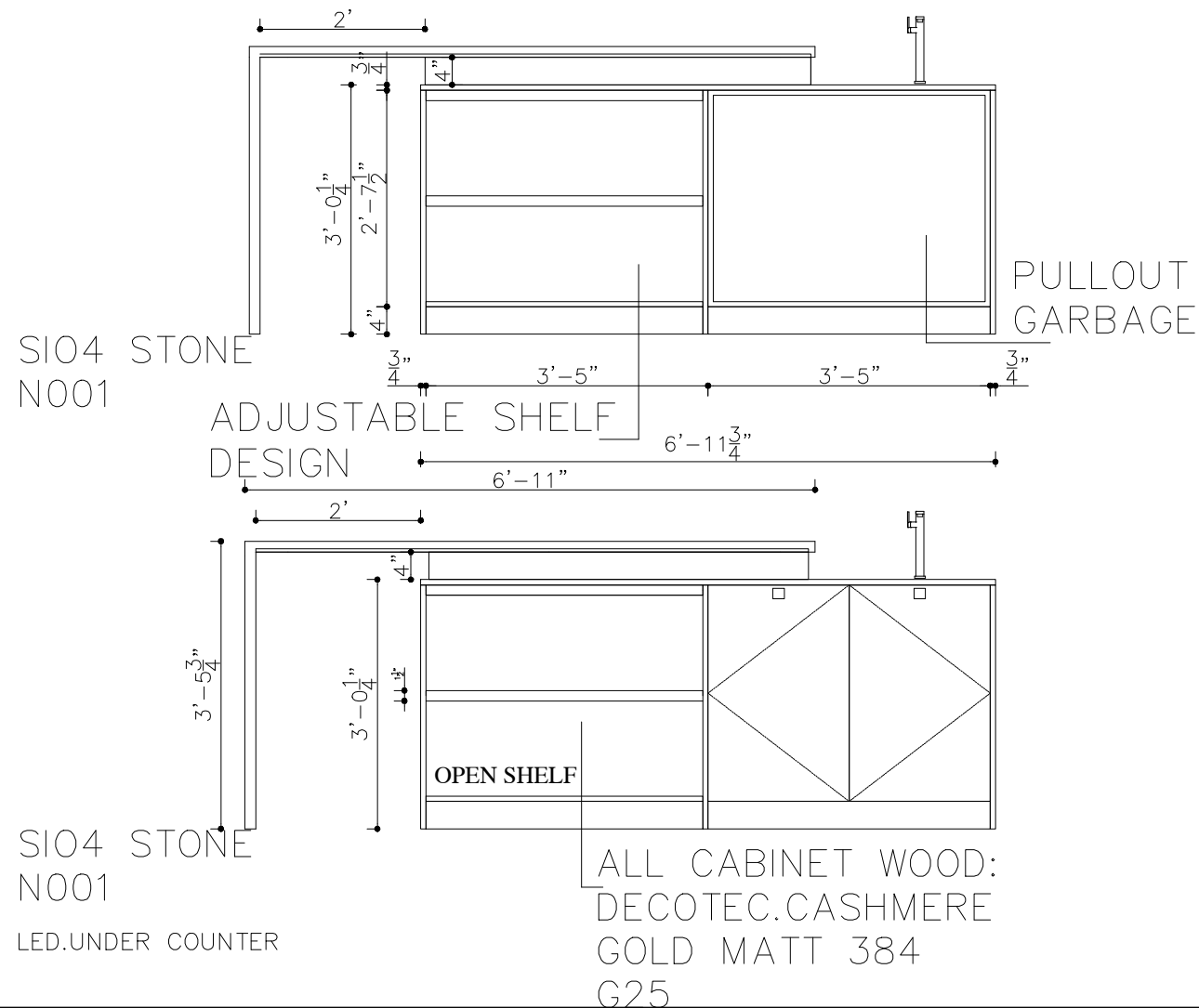

VIEW B

THE BEGINNING OF THE COUNTERTOP IS EQUAL TO THE END OF THE INDENTATION OF SIDE WALL

TWO SIDES OF COUNTER AND COUNTER TOP STONE DESIGN/ FURTHER MORE [L]SHAPE COUNTER UP WITH SAME STONE DESIGN

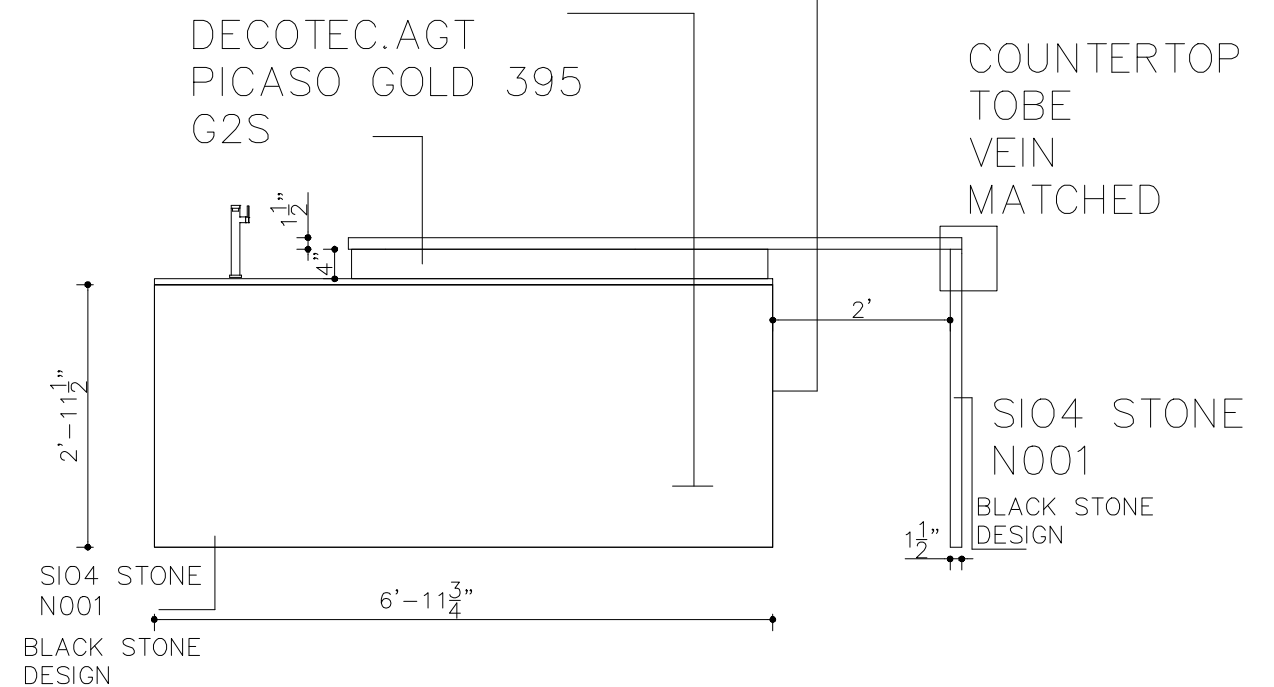

VIEW C



PROJECT TITLE:
173 MINEOLA ROAD EAST

TITLE:
BAR DESIGN

All dimensions are subject to verification and adjustment on jobsite to fit job condition.

PRODUCED BY:
N.M

SIGN&DATE: